

Operating and Installation Instructions Combi Steam Oven

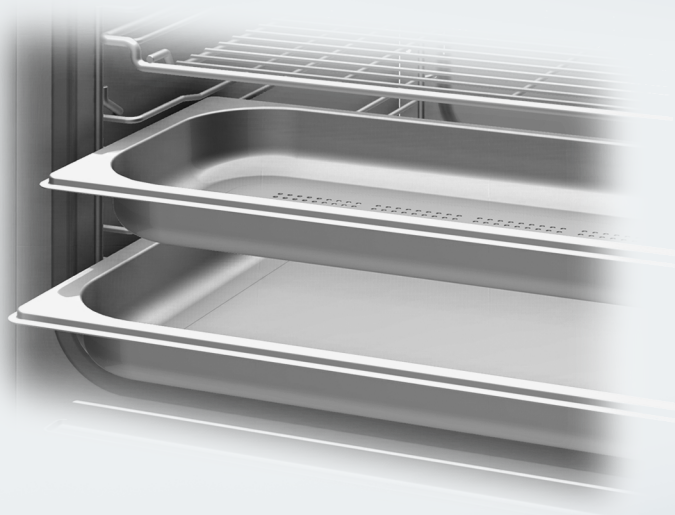

To prevent accidents and machine damage, read these instructions **before** installation or use.

Contents



IMPORTANT SAFETY INSTRUCTIONS	7
Overview	16
Front view	16
Included accessories	18
Control panel	19
Sensor buttons	20
Display	21
Symbols	21
Description of functions	22
Control panel	22
Water container	22
Condensate container	22
Grease filter	22
Roast probe	22
Temperature / Core temperature	22
Moisture content	23
Cooking duration	23
Noises	23
Preheating phase	24
Cooking phase	24
Steam reduction	24
Oven interior lighting	24
Before using for the first time	25
General settings	25
Cleaning for the first time	26
Setting the water hardness level	27
Setting the correct boiling point for water	28
Heating up the steam oven	28
Modes / Programs / Menus	29
Operation: Steam cooking	32
Quick guide	32
After use	33
Interrupting operation	34
Additional functions	35
Turning on and off automatically	36
Sequence of an automatic cooking process	36
Changing settings during a cooking process	37
Canceling cooking	37

Operation: Combination cooking mode	38
Quick guide	39
After use	41
Interrupting operation	41
Additional functions	42
Turning on and off automatically	42
Sequence of an automatic cooking process	43
Changing settings during a cooking process	43
Canceling cooking	43
Operation: Functions without steam	44
Quick guide	45
Interrupting operation	46
Additional functions	47
Turning off automatically	48
Turning on and off automatically	48
Sequence of an automatic cooking process	49
Rapid PreHeat	49
Changing the oven mode	50
Changing settings during a cooking process	50
Canceling cooking	51
MasterChef	52
List of automatic programs	52
Using the MasterChef programs	53
Favorites	54
Creating a Favorite	54
Starting a Favorite	56
Changing Favorites	56
Changing cooking stages	56
Changing the name	57
Deleting a Favorite	57
Timer	58
Setting the timer	58
Resetting the timer	58
Canceling the timer	58
General notes	59
The advantages of cooking with steam	59
Suitable containers	59
Cooking pans	59
Your own pans	59

Contents

Shelf level	60
Frozen food.....	60
Temperature	60
Cooking duration.....	60
Cooking with liquid.....	60
Your own recipes - Steam cooking	60
Wire oven rack / universal tray	61
Steam cooking	62
Vegetables.....	62
Meat	65
Sausage.....	67
Fish.....	67
Shellfish	70
Mussels	71
Rice	72
Pasta	73
Dumplings	74
Grains	75
Legumes.....	76
Eggs	78
Fruit	79
Menu Cooking - Manual.....	80
Sous-vide (vacuum) cooking	82
Special modes	87
Reheat	87
Defrost.....	89
Canning	92
Juicing	94
Menu Cooking	95
Dehydrate	96
Making Yogurt	97
Proofing	98
Dissolving Gelatine.....	99
Melting Chocolate	99
Skinning Fruits and Vegetables	100
Preserving Apples	101
Blanching.....	101
Sweating Onions	102
Rendering Fat	102
Sanitizing Cookware	103
Heating Damp Towels	103

Contents

Decrystallizing Honey	104
Pizza	104
Making jam	105
Sabbath Program	106
Roast probe	107
Roast	110
Bake	117
Broil	124
Settings	127
Accessing the "Settings" menu	127
Changing and saving settings	127
Settings overview	128
Language 	129
Time of day	129
Display	129
Clock format	129
Setting the time	129
Date	129
Lighting	130
Display brightness	130
Acoustic tone information	130
Melody	130
Solo tone	130
Keypad tone	131
Units of measurement	131
Weight	131
Temperature	131
Keeping Warm	132
Automatic rinsing	132
Default temperatures	133
Safety	133
System lock 	133
Sensor lock	134
Water hardness	134
Showroom Program	135
Demo Mode	135
Factory default	135

Contents

Cleaning and care	136
Important information on cleaning and care	136
Appliance front	137
PerfectClean	138
Oven interior	139
Water container and condensate container	141
Accessories	141
Shelf runners	142
Maintenance	143
Soak	143
Drying	143
Rinsing	143
Descaling	143
Door	145
Frequently asked questions	147
Optional accessories	152
Cooking pan	152
Cleaning and care products	154
Additional accessories	155
IMPORTANT SAFETY INSTRUCTIONS - INSTALLATION	157
Detailed dimensions of oven front	158
Installation dimensions	160
Installation into a tall cabinet	160
Undercounter installation	162
Installation in combination with an oven	164
Installation	166
Electrical connection	167
Power Supply	167
Caring for the environment	168
Technical service, data plate, warranty	169
MieleCare	170

IMPORTANT SAFETY INSTRUCTIONS

The Combi Steam oven is referred to in the following instructions as steam oven.

This appliance conforms to current safety requirements. Inappropriate use can, however, lead to personal injury and damage to property.

To avoid the risk of accidents and damage to the appliance, please read these instructions carefully before installing or using it for the first time. They contain important notes on installation, safety, use and maintenance.

Keep these instructions in a safe place and pass them on to any future owner.

SAVE THESE INSTRUCTIONS

IMPORTANT SAFETY INSTRUCTIONS

Use

- ▶ This appliance is intended for residential use only.
- ▶ The steam oven is not suitable for outdoor use.
- ▶ This steam oven is intended for domestic use only as described in these operating instructions.
Any other usage is not supported by the manufacturer and could be dangerous.
- ▶ Persons who lack physical, sensory or mental abilities, or experience with the appliance should not use it without supervision or instruction by a responsible person.

IMPORTANT SAFETY INSTRUCTIONS

Children

- ▶ Activate the system lock to ensure that children cannot switch on the steam oven inadvertently.
- ▶ Children must not be allowed to clean the steam oven unsupervised.
- ▶ Please supervise children in the vicinity of the steam oven and do not let them play with it.
- ▶ As with any other appliance, you must constantly keep an eye on children while the steam oven is in operation.
- ▶ Danger of suffocation! Ensure that any plastic wrappings, bags, etc. are disposed of safely and kept out of the reach of children.
- ▶ Danger of burning. Children's skin is far more sensitive to high temperatures than that of adults. The door, control panel and the ventilation cut-outs for oven compartment ventilation all get hot. Make sure that children do not touch the steam oven or attempt to open the door when it is in operation. Keep children well away from the appliance until it has cooled down and there is no danger of burning.
- ▶ Risk of injury! The maximum allowable weight on the door is 22 lbs (10 kg).
Do not allow children to hang, lean or sit on the door when open.

IMPORTANT SAFETY INSTRUCTIONS

Technical safety

- ▶ Installation, repair and maintenance work should be performed by a Miele authorized service technician in accordance with national and local safety regulations and the provided installation instructions. Contact Miele's Technical Service Department for examination, repair or adjustment. Repairs and other work by unauthorized persons could be dangerous and may void the warranty.
- ▶ A damaged appliance is dangerous. Check the appliance for any visible damage. Never install or attempt to use a damaged appliance.
- ▶ Reliable and safe operation of this steam oven can only be assured if it has been connected to the mains electricity supply.
- ▶ Be certain your appliance is properly installed and grounded by a qualified technician. To guarantee the electrical safety of this appliance, continuity must exist between the appliance and an effective grounding system. It is imperative that this basic safety requirement be met. If there is any doubt, have the electrical system of the house checked by a qualified electrician.
- ▶ Before connecting the appliance to the mains supply, ensure that the connection data on the data plate (voltage and frequency) match the mains electricity supply.
This data must correspond in order to avoid the risk of damage to the appliance. Consult a qualified electrician if in any doubt.
- ▶ Do not use an extension cord to connect this appliance to the power supply. Extension cords do not guarantee the required safety of the appliance.
- ▶ For safety reasons, this appliance may only be used after it has been built in.
- ▶ This steam oven must not be used in a non-stationary location (e.g. on a ship).

IMPORTANT SAFETY INSTRUCTIONS

- ▶ Tampering with electrical connections or components and mechanical parts is highly dangerous to the user and can cause operational faults. Do not open the outer casing of the appliance.
- ▶ While the appliance is under warranty, repairs should only be performed by a Miele-authorized service technicians. Work by unqualified persons could be dangerous and may void the warranty.
- ▶ Defective components should be replaced by Miele original parts only. Only with these parts can the manufacturer guarantee the safety of the appliance.
- ▶ If the plug has been removed or the power cord is not supplied with a plug, the steam oven must be connected to the power supply by a suitably qualified electrician.
- ▶ If the power cord is damaged, it must be replaced with a special connection cable type H 05 VV-F (PVC insulated). See "Electrical connection."
- ▶ Before installation, maintenance, and repair work, the steam oven must be disconnected from the electrical supply. It is only completely isolated from the electrical supply if: the fuse has been removed (where applicable), the main circuit breaker has been tripped, or the power cord has been unplugged from the wall outlet. Always be sure to pull the plug not the cord.
- ▶ If the steam oven is installed behind a cabinet door, do not close the door while the appliance is in operation. Heat and moisture can build up behind the closed door and cause damage to the range and to the surrounding cabinets and flooring. Do not close the door until the appliance has completely cooled down.
- ▶ Do not repair or replace any part of the appliance unless specifically recommended in the manual. All other servicing should be referred to a qualified technician.

IMPORTANT SAFETY INSTRUCTIONS

▶ Do not operate any appliance with a damaged cord or plug, or if the appliance has been damaged in any manner. Contact Miele's Technical Service Department.

Proper use

▶ Danger of burning. The steam oven becomes hot when in use. You could burn yourself on the heating elements, oven interior, cooked food, oven accessories or hot steam. Use pot holders when placing food in the oven or removing it and when adjusting oven shelves etc. in a hot oven. Take care when putting cooking pans into the oven or removing them not to spill the contents.

▶ Do not heat up food in closed containers e.g. tins or sealed jars in the steam oven, as pressure will build up in the container, causing it to explode.

▶ Plastic containers which are not suitable for use in an oven can melt at high temperatures and can even damage the steam oven or catch fire.



Only use plastic containers which are declared by the manufacturer as being suitable for use in a steam oven. Follow the manufacturer's instructions on use. If you want to use plastic containers for steaming food make sure that they are temperature resistant to 210°F / 100°C and steam resistant. Any other plastic containers could melt, become brittle or break when subjected to heat.

▶ Food which is left in the oven to be kept hot can dry out and the moisture released can lead to corrosion damage in the appliance. Do not use the steam oven for keeping food warm and do not use utensils in the appliance which could corrode.

▶ Do not leave the appliance door open unnecessarily as someone may trip over it or be injured by it.

▶ The door can support a maximum weight of 22 lbs (10 kg). Do not sit, lean or place heavy items on the open oven door. Also be sure nothing can get trapped between the door and the oven cavity. The steam oven could get damaged.

IMPORTANT SAFETY INSTRUCTIONS

- ▶ Oil and fat can ignite if overheated. Never leave the steam oven unattended when cooking with oil and fat.
If it does ignite do not put the flames out with water. Switch the steam oven off immediately and then suffocate the flames by keeping the oven door closed.
- ▶ Smother the fire or flames, or use a dry chemical extinguishing agent or foam fire extinguisher.
- ▶ Due to the high temperatures radiated, objects left near the steam oven when it is in use could catch fire.
Do not use the steam oven to heat up the room.
- ▶ Broiling food for an excessively long time can cause it to dry out with the risk of catching fire.
Do not exceed recommended broiling times.
- ▶ Some foods dry out very quickly and can be ignited by high broiling temperatures. Do not use broiling functions for crisping rolls or bread or to dry flowers or herbs. Instead use the Convection Plus  or Surround  functions.
- ▶ To avoid fueling any flames, do not open the appliance door if you see smoke coming from the food in the oven interior. Interrupt the current process by turning off the appliance and disconnecting it from the power. Do not open the door until the smoke has dissipated.
- ▶ Use caution when using alcohol in your recipes. Alcohol evaporates at high temperatures but may, in rare circumstances, combust on the hot heating elements.
- ▶ Never cover the floor of the oven with aluminum foil, or place oven dishes, pans, saucepans or trays directly onto the floor of the oven.
- ▶ Never use the steam oven without a drain filter as large food residues may block the drain and the pump.
- ▶ To prevent the risk of damage, do not leave the roast probe in the oven cavity when it is not being used.

IMPORTANT SAFETY INSTRUCTIONS

- ▶ When using an electrical appliance, e.g., a hand-held mixer, near the steam oven, make sure that the power cord does not get caught in the door. The insulation on the cord could become damaged, giving rise to an electric shock hazard.
- ▶ Do not operate the appliance without the lamp cover. Steam could attack the electrical components and cause a short circuit. Steam could also damage the electrical components.
- ▶ The steam oven should be installed at a safe height for users to safely access all cooking levels and pans. Otherwise spills could cause burns or scalding and children may be put at risk by the hot appliance door.
- ▶ Flammable materials should not be stored in an oven or in the vicinity of the cooktop.
- ▶ Open the door carefully to allow hot air or steam to escape before placing or removing food.
- ▶ Keep the oven vent ducts open.
- ▶ Wear proper apparel - Loose-fitting or hanging garments should never be worn while using the appliance.
- ▶ To prevent burns, always place oven racks at their desired height while the steam oven is cool. If the rack must be moved while the oven is hot, do not let pot holders touch hot heating elements.
- ▶ Caution: Heating elements may be hot even though they are not glowing. Interior surfaces of an steam oven become hot enough to cause burns. External parts of the steam oven such as the door glass, vents, and the control panel can become hot. During and after use, do not touch, or let clothing or other flammable materials come into contact with heating elements or interior surfaces of the steam oven until they have had sufficient time to cool.

IMPORTANT SAFETY INSTRUCTIONS

Cleaning and care

- ▶ Do not use a steam cleaner to clean this oven. Steam could penetrate electrical components and cause a short circuit.
- ▶ Scratches on the door glass can cause the glass to break. Do not use abrasive cleaners, hard sponges, brushes or sharp metal tools to clean the door glass.
- ▶ The side runners can be removed for cleaning purposes (see "Cleaning and care"). Ensure that they are replaced correctly and do not use the oven without them in place.
- ▶ To avoid corrosion on the stainless steel surfaces of the Speed Oven, remove any splashes on the interior walls of the oven from food or liquids containing salt.

Accessories

- ▶ Use only genuine original Miele parts. If parts or accessories from other manufacturers are used, the warranty will become void.
- ▶ Only use the Miele roast probe supplied with this oven. If it is faulty, it must only be replaced with a Miele genuine roast probe.

Overview

Front view

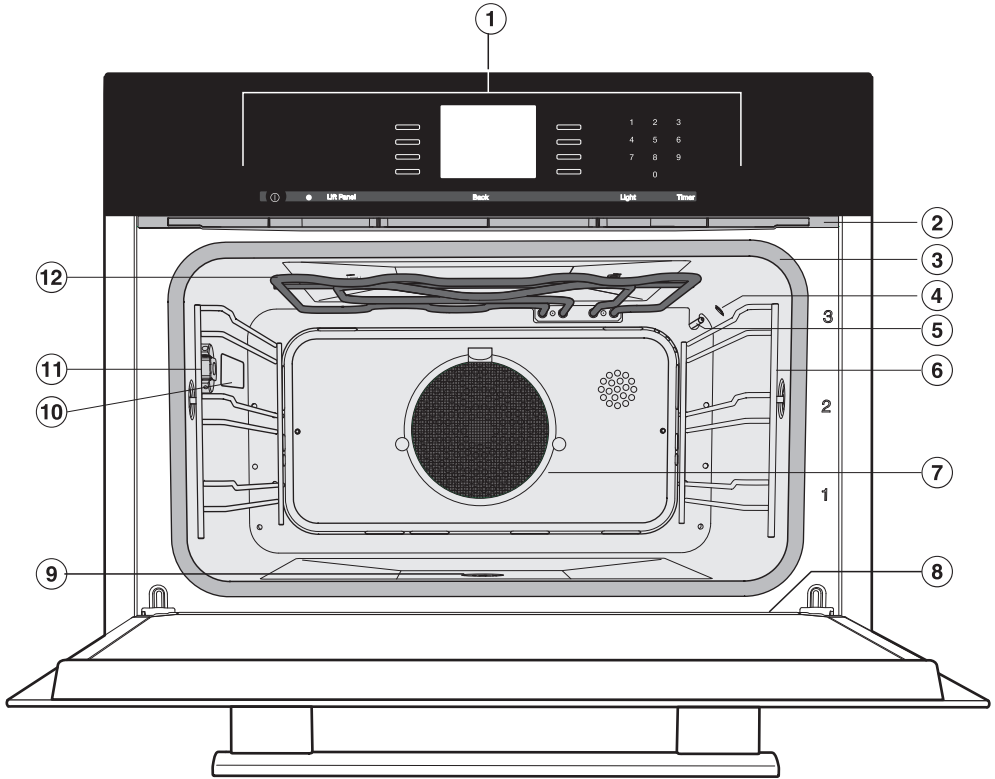

- | | |
|------------------------------------|---|
| ① Control panel | ⑦ Grease filter |
| ② Vent | ⑧ Drip channel |
| ③ Door gasket | ⑨ Drain |
| ④ Moisture sensor | ⑩ Oven interior lighting |
| ⑤ Temperature sensor | ⑪ Connection socket for the roast probe |
| ⑥ Side runners with 3 shelf levels | ⑫ Browning / Broiling element |

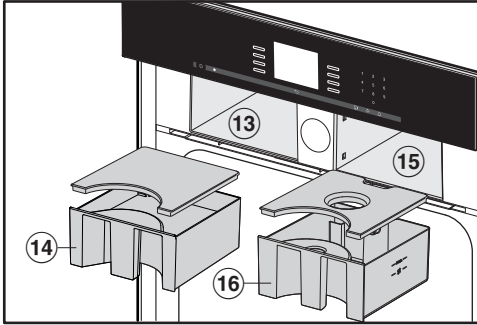

- ⑬ Slide-in compartment for condensate container
- ⑭ Condensate container
- ⑮ Slide-in compartment for water container
- ⑯ Water container

Overview

Included accessories

The accessories supplied with your appliance, as well as a range of optional ones, are available to order from Miele (see "Optional accessories").

DGGL 20

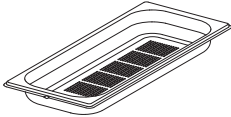

1 perforated cooking pan
17 11/16" x 7 1/2" x 1 9/16" (WxDxH)
450 x 190 x 40 mm (WxDxH)

DGG 20

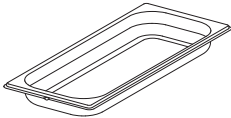

1 solid cooking pan
17 11/16" x 7 1/2" x 1 9/16" (WxDxH)
450 x 190 x 40 mm (WxDxH)

Universal tray

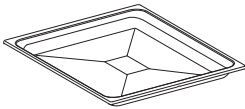

1 universal tray for baking, roasting and broiling

Wire oven rack



1 wire oven rack for baking, roasting and broiling

Roast probe



1 roast probe for precise temperature controlled cooking, which monitors the internal temperature of the meat (core temperature).

Control panel

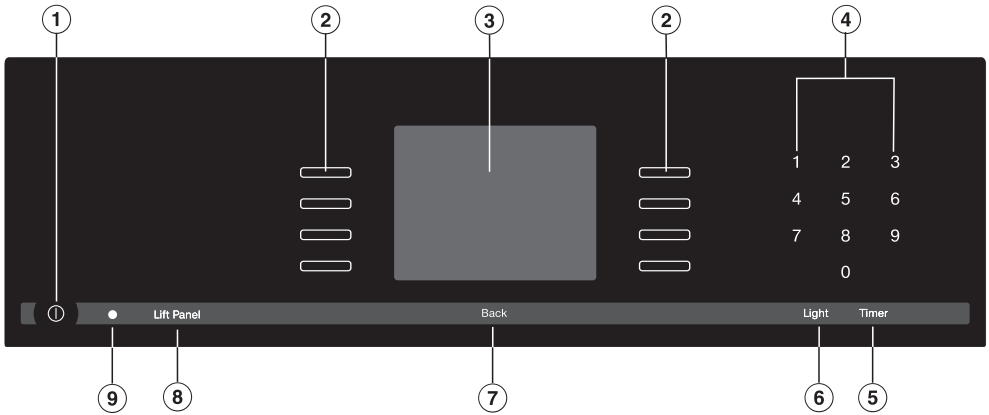



- ① Recessed On / Off ① button
To turn the appliance on and off
- ② Sensor buttons 
To select operating modes, settings and menu items
- ③ Display
Displays the time of day and information on operation
- ④ Sensor buttons 0-9
Numeric keypad to enter values
- ⑤ "Timer" sensor button
To set the timer
- ⑥ "Light" sensor button
To turn the oven interior lighting on and off
- ⑦ "Back" sensor button
To go back one step at a time
- ⑧ "Lift Panel" sensor button
For opening/closing the control panel
- ⑨ Optical interface
(for service technician use only)

Control panel

Sensor buttons

The sensors react to touch. Each touch is confirmed with an audible tone. This tone can be turned off (see "Settings – Keypad tone").



Sensor button	Function	Notes
	For selecting options and scrolling through the list of options.	A menu items can be selected by touching the illuminated sensor button  next to it.
0–9	Numerical keypad for setting values	The numerical keypad is used to set values, e.g. temperatures and durations.
Timer	For setting the timer	If a list of options is showing on the display or if a cooking process is running, a timer duration (e.g. when boiling eggs) can be set at any point. If the display is dark, the "Timer" sensor button will not react until the steam oven is turned on.
Light	For turning the oven interior lighting on and off	If a list of options is showing in the display or if a cooking process is running, tapping "Light" will switch the oven interior lighting on or off, for example when cleaning the oven. If the display is dark, the "Light" sensor button will not react until the steam oven is turned on. The oven interior lighting turns off after 15 seconds during cooking or remains constantly turned on, depending on the setting selected.
Lift Panel	For opening/closing the control panel	
Back	To go back a step	

Display

The display is used for showing the time of day or information about modes, temperatures, cooking durations, MasterChef programs and settings. Information or a list of options is shown on the display depending on the function selected.







After switching the oven on with the On/Off sensor button , the main menu will appear.

If a cooking process is running, selecting **Change** will call up a list of options which can be set or changed for the cooking process in progress.

- Touch the illuminated  sensor button beside the option to select it.
- Options can then be accessed by tapping the illuminated sensor button  next to OK.

Symbols

The following symbols may appear in the display:

Symbol	Description
-	Allocates an illuminated Sensor button  to an option and indicates that the option can be selected.
	If more than four options are available a bar will appear on the right-hand side of the display. Use the allocated sensors to scroll through the list.
.....	The end of a list is indicated by a dotted line. By scrolling down further, you will reach the beginning of the list again.
+ / -	These only appear when an entry is possible or necessary (e.g. entering the date).
✓	A check indicates the option which is currently selected.
i	This symbol indicates that there is additional information and advice about using the oven. Select OK to access the information.
	Water level indicator
	Start time
	Program finished
	Timer
	Some settings, e.g. display brightness and buzzer volume, are selected using a bar chart.

Description of functions

Control panel

The water container and condensate container are located behind the control panel. The control panel is opened and closed using the "Lift Panel" sensor. The panel is equipped with a device which will automatically stop it moving if it meets an obstruction while opening or closing. Do not touch the door handle while the panel is opening or closing.

Water container

The maximum water level is 3 pints (1.4 liters), the minimum 1 quart (1 liter). These levels are indicated on the container. Do not exceed the maximum level.

The amount of water depends on the type of food and the duration of cooking. You may need to refill the water container during the cooking procedure. Opening the door will increase the amount used.

Fill the water container to the maximum level before each use.

Condensate container

Condensate that collects in the appliance from cooking is pumped into the condensate container. The container has a maximum capacity of 3 pints (1.4 liters).

Grease filter

Insert the grease filter in the back wall for all roasting programs. It should be removed when using steam programs. It must also be removed when baking, as otherwise results can be uneven (exception: deep fresh fruit pies, pizza with extra toppings).

Roast probe

The roast probe measures the core temperature in the food, enabling the temperature during the cooking process to be monitored simply and accurately.

Temperature / Core temperature

Some functions have a default temperatures. This temperature can be altered within the given range for the program or program stage in use, or for every time that program is used (see "Settings - Recommended temperatures"). The core temperature can also be changed within a given range for an individual cooking process or cooking stage.

Moisture content

The Combi Steam and Reheat modes use a combination of oven heat and moisture. You can alter the moisture/humidity level within a given range for an individual cooking program or a cooking stage.

Depending on the setting for the program, either moisture or fresh air is injected into the oven. If the humidity level is set to 0%, the maximum amount of air will be injected and no moisture. If the level is set to 100%, air will not be injected into the oven and the maximum amount of moisture will be injected.

Some food gives off moisture during the cooking process. This moisture from the food also controls the amount of moisture needed. If the required amount of moisture is very low and the food already contains a lot of water the steam generator may not be activated at all.

Cooking duration

Depending on the function, you can set a cooking duration of between 1 minute and 6, 10 or 12 hours.

The duration of the MasterChef, Maintenance and Menu Cooking programs is set at the factory and cannot be altered.

With the Steam Cooking function and programs that use steam alone, the cooking duration does not start to count down until the set temperature has been reached. It begins immediately with all other functions and programs.

Noises

You will hear a pumping sound when the appliance is turned on, during use and after turning it off. This is the sound of water being pumped through the system and is quite normal.

When the steam oven is in use, you will hear a fan noise.

Description of functions

Preheating phase

During the preheating phase the display will show the temperature in the cooking compartment as it rises and Pre-Heating in all programs except for MasterChef, Menu Cooking, and Maintenance.

During steam cooking, the duration of the preheating phase will depend on the quantity and the temperature of the food. In general this phase will last for approx. 5 minutes. The duration will be longer if you are preparing refrigerated or frozen food.

Cooking phase

The cooking phase begins when the set temperature is reached. During the cooking phase, the time left will be shown on the display.

Steam reduction

If cooking is performed in a certain temperature range during steam cooking and combination cooking, the steam reduction function switches on automatically at the end of the cooking program. This reduces the amount of steam which escapes from the appliance when the door is opened at the end of the cooking duration. Steam Reduction will appear in the display in addition to Program Finished.

This function can be switched off if you wish (see "Settings - Steam reduction").

Oven interior lighting

The oven light has been set at the factory to go out when cooking starts.

If you want it to stay on all the time the oven is on you will need to alter the default setting (see "Settings - Lighting").

If the door is left open at the end of a cooking program, the oven lighting will turn off automatically after 5 minutes.

The oven lighting gives off heat. If you are operating the combi steam oven at a temperature below 125°F (50°C), the oven compartment lighting switches off automatically.

If the "Light" button on the control panel is pressed, the oven compartment lighting will come on for 15 seconds.

Before using for the first time

General settings

 The steam oven must not be operated until it has been correctly installed.

The steam oven will turn on automatically when it is connected to the power supply.

Welcome screen

A welcome screen is displayed. You will then be asked to select some basic settings which are needed before the appliance can be used.

- Follow the instructions on the display.

Set the language

- Scroll through the list until the desired language appears.
- Touch the illuminated  sensor button next to the language you want to select.
- Confirm with OK.

Set the country

- Scroll through the list until the desired country appears.
- Touch the illuminated  sensor button next to the country you want to select.
- Confirm with OK.

Set the date

- Use + or – to set the year, month and day.
- Confirm with OK.

Set the time of day

- Use the numerical keypad to set the time of day in hours and minutes (e.g. 1-2-1-5 for 12:15).
- Confirm with OK.

The time of day can be displayed in 12-hour format (see "Settings - Time of Day - Clock Format").

Before using for the first time

Time of day format

You will then be asked when you want the time of day to show on the display when the steam oven is turned off (see "Settings - Time of Day - Display"):

– On

The time is always visible on the display.

– Off

The display appears dark to save energy. Some modes are limited.

– Night Dimming

The time only shows on the display between 5:00 am and 11:00 pm. It turns off at night to save energy.

■ Select the desired option.

■ Confirm with OK.

Information regarding energy consumption will appear on the display.

■ Confirm with OK.

Set up Successfully Completed is displayed.

■ Confirm with OK.

The steam oven is ready for use.

If you accidentally select the wrong language, follow the instructions described in "Settings - Language 🗇."

■ Please adhere the extra data plate for the appliance supplied with this documentation in the space provided in the "Technical service, data plate, warranty" section of this manual.

■ Remove any protective foil and stickers.

The appliance has undergone a function test in the factory. Residual water from this testing may have dripped from the lines into the oven cavity during transportation.

Cleaning for the first time

Water container and condensate container

 Danger!

Do not touch the door handle when opening the control panel. Your fingers could be pinched.

■ Tap "Lift Panel" to open the control panel.

■ Remove the water container and condensate container. Push upwards slightly as you take them out of the appliance.

■ Rinse the water container / condensate container by hand or in the dishwasher.

Accessories / Oven interior

- Remove all accessories from the steam oven.
- Wash them by hand using hot water and a soft clean sponge and a mild solution of warm water and liquid dish soap or in the dishwasher.

Risk of damage to the surfaces of the universal tray and the wire oven rack.

The universal tray and wire oven rack are treated with PerfectClean and must **only** be cleaned by hand. See "Cleaning and care - Perfect-Clean" for more information.

- Clean the universal tray and wire oven rack with a solution of warm water and liquid dish soap applied with a soft sponge.

The interior of the steam oven has been treated at the factory with a conditioning agent.

- To remove this, clean the oven interior with warm water and liquid dish soap and then dry thoroughly with a soft cloth.

Setting the water hardness level

The steam oven is factory set for Hard water. It must be adjusted local water hardness to ensure trouble-free operation and to ensure that descaling is carried out at the correct interval. The harder the water, the more often it will need to be descaled.

- Check the hardness of your local water supply and adjust the water hardness as necessary (see "Settings - Water hardness").

Before using for the first time

Setting the correct boiling point for water

Before cooking food for the first time, you must set the boiling point for water, as this varies depending on the altitude of the installation location of the appliance. This procedure also flushes out the waterways.

This procedure **must** be carried out to ensure efficient functioning of your appliance.

Only use cold tap water (less than 68°F / 20°C). Never use distilled or mineral water or other liquids.

- Remove the water container and fill it to the "max" marker.
- Push the water container into the appliance until it engages.
- You should then run the Steam Cooking program at 210°F / 100°C for 15 minutes. Proceed as described in "Operation – Steam cooking."

Resetting the correct boiling point for water

If you move, the appliance will need to be re-set for the new altitude if this differs from the old one by 984 ft (300 m) or more. To do this, descale the appliance (see "Cleaning and care – Maintenance – Descaling").

Heating up the steam oven

- To remove the grease from the ring heating element, heat the appliance up with nothing in it at 400°F / 200°C using the Convection Bake function for 30 minutes.
Proceed as described in "Operation – Functions without steam."

There will be a slight smell the first time the heating element is heated up. The smell and any vapors will dissipate after a short time, and do not indicate a faulty connection or appliance.

It is important to ensure that the kitchen is well ventilated during this operation.

Modes / Programs / Menus

	Default temperature/ Setting	Temperature range
Operating Modes		
Convection Bake For baking on several levels at the same time. The fan distributes the heat evenly throughout the cavity for a consistent baking temperature.	320°F / 160°C	85-435°F / 30-225°C
Surround Heat is used from both the upper and lower heating elements to create perfect results of all baking recipes.	350°F / 180°C	85-435°F / 30-225°C
Combi Steam For baking, roasting and broiling. For more information see "Operation: Combination cooking mode", "Roast", "Bake"		
Convection Bake	340°F / 170°C	85-435°F / 30-225°C
Surround	350°F / 180°C	85-435°F / 30-225°C
Maxi Broil	Level 3	Levels 1-3
Steam Cooking Retains the flavor and nutrients of the food without added fats or oils	210°F / 100°C	105-210°F / 40-100°C
Sous-vide (vacuum) cooking Cooking food in a vacuum bag	150°F / 65°C	115-195°F / 45-90°C
Intensive This mode gently circulates heated air from the lower heating element using the fan to create a brick oven environment.	350°F / 180°C	120-435°F / 50-225°C
Bake Use this at the end of the baking time to brown the bottom of the food.	375°F / 190°C	210-435°F / 100-225°C
Browning For a perfectly browned topping, for example when making a gratin or browning the top of a casserole.	375°F / 190°C	210-435°F / 100-225°C

Modes / Programs / Menus

	Default temperature/ Setting	Temperature range
Operating Modes		
Maxi Broil The entire upper heating element is used for intense heating from above. Excellent browning and searing results can be achieved.	Level 3	Level 1-3
Broil For broiling smaller quantities of steak, chops, kebabs, etc.	Level 3	Level 1-3
Convection Broil This mode distributes hot air from the Browning/Broiling element over the food using the fan.	400°F / 200°C	120-435°F / 50-225°C
Humidity Plus A special baking program for light pastries, cakes and baked goods.	320°F / 160°C	85-435°F / 30-225°C
Gentle Bake For cooking sweet and succulent bakes and gratins	320°F / 160°C	85-435°F / 30-225°C
MasterChef The list of available MasterChef programs is displayed.		
Special Modes		
Menu Cooking Simultaneous cooking of various foods	–	–
Pizza	350°F / 180°C	350-435°F / 180-225°C
Defrost For gentle thawing of frozen foods	140°F / 60°C	120-140°F / 50-60°C
Reheat To gently reheat already cooked foods	265°F / 130°C	248-284°F / 120-140 °C

Modes / Programs / Menus

	Default temperature/ Setting	Temperature range
Special Modes		
Blanching	–	–
Canning	195°F / 90°C	175-210°F / 80-100°C
Sanitize Cookware	–	–
Dehydrate	140°F / 60°C	140-160°F / 60-70 °C
Proof	–	–
Sabbath Program	350°F / 180°C	85-435°F / 30-225°C
Favorites		
Create and save your favorite dishes		
Settings 		
Changing the factory default settings		
Maintenance		
Descal	–	–
Soak	–	–
Drying	–	–
Rinses	–	–

Operation: Steam cooking

A fault can occur if the drain is blocked.

Check that the drain filter is correctly in place before each program as large food residues can clog the drain.

Quick guide

- Turn the steam oven on with ⓪.

The main menu appears on the display.

Only use cold tap water (less than 70°F / 20°C). Never use distilled or mineral water or other liquids.

- Fill the water container and push it back in so that it engages.
- Put the food in the oven.
- Select Operating Modes.
- Select Steam Cooking.

Set the Temperature appears on the display.

- Adjust the recommended temperature if necessary.
- Confirm with OK.

The recommended temperature will be automatically accepted within a few seconds.

If necessary, select "Back" to go back to the temperature setting (see "Additional functions - Changing the temperature").

Garzeit einstellen appears on the display.

- Set the cooking duration. Any time between 1 minute and 10 hours can be set.
- Confirm with OK.

The cooking process begins. The steam condenser, lighting, and fan turn on.

- Set further settings as necessary (see "Additional functions")

Operation: Steam cooking

At the end of the cooking duration

- Steam Reduction (with temperatures over approx. 175°F / 80°C) and Program Finished will appear in the display,
- The fan remains on.
- A buzzer or melody will sound (see "Settings - Acoustic information").

You have the option to save the program as a Favorite (see "Favorites") or to increase the cooking duration using Change. Tap "Back" to go back to the main menu.

Burn hazard!

You could burn yourself on the oven interior walls, spilled food and accessories

Use pot holders when removing hot food from the oven.

- Wait until Steam Reduction goes out on the display before opening the door and removing the food.

After use

- Remove and empty the water container and condensate container. Push upwards slightly as you take them out of the appliance.
- Turn the steam oven off ①.

Following a cooking program with steam, Appliance Rinsing will appear in the display after the steam oven has been switched off.

This process should be carried out every time to flush any remaining food deposits out of the system.

- Follow the instructions on the display
- After each use, clean and dry the whole appliance as described in "Cleaning and care."
- Leave the appliance door open until the oven interior is completely dry.

Insufficient water

If the steam oven runs out of water during operation, an audible tone will sound and the display will prompt you to fill the water container with fresh tap water.

- Remove the water container and fill it with fresh tap water.
- Push the water container into the appliance until it connects.
- Close the door.

Operation will continue.

Operation: Steam cooking

Interrupting operation

Operation is interrupted as soon as the door is opened. The heating will be turned off and the cooking duration remaining stored in memory.



Burn hazard!

Steam can escape when the door is opened.

Step back and wait until the steam has dissipated.



Burn hazard!

You could burn yourself on the oven interior walls, spilled food and hot steam.

Use pot holders when inserting, removing or turning hot food, or when adjusting shelves, etc. in a hot oven.

Operation will resume when the door is closed.

The oven will heat up again and the display will show the temperature of the cooking compartment as it rises.

Once the set temperature has been reached, the display will change to show the cooking duration remaining as it counts down.

The cooking process will be ended early if the door is opened during the last minute of cooking (55 seconds standing time).

Additional functions

Setting additional durations

You have placed the food in the oven, selected a temperature and a duration.

- Select **Change**.

Additional menu items will appear. You can select or change these options for the cooking program:

- Ready at
- Start at
- Change Mode
(see "Changing settings during a cooking process - Changing a function")

You can set the program to turn off or on and off automatically by entering **Ready at** or **Start at**.

- Ready at
You specify the time you want cooking to stop.
- Start at
You specify the time you want cooking to start.

Cooking results can be impaired if there is a long delay between the food being placed in the oven and the start of cooking. Fresh food can change its color and even deteriorate.

If the temperature in the oven is too high, e.g. directly after another program, you will not be able to use this function. **Ready at** and **Start at** will not appear on the display if this is the case. Open the oven door until the appliance has cooled down.

A **Ready at** time cannot be entered if you are using the roast probe. When using the roast probe, the end of the cooking duration is determined by when the set core temperature is reached. Only **Start at** can be selected.

Operation: Steam cooking

Turning on and off automatically

To turn a cooking program on and off automatically, you have a choice of how to enter the time parameters:

- Duration and Ready at
- Duration and Start at

Example: It is now 11:45 am. The food takes 5 minutes to cook and needs to be ready at 12:30 pm.

- Select Change.
- Select Duration and set a duration of "00:05."
- Confirm with OK.
- Select Ready at and set "12:30."
- Confirm with OK.

Start at is calculated automatically. The cooking duration entered is added to the preheating time calculated by the steam oven.

Start at 12:18 appears on the display. The cooking process will start automatically at this time.

Sequence of an automatic cooking process

Up until the start time the function, the selected temperature, Start at and the start time will appear in the display.

After the start time during the preheating phase you can follow the temperature increasing in the display. When the required temperature is reached a buzzer or a melody will sound (see "Settings - Acoustic information").

After the preheating phase, the cooking duration (time left) will count down on the display. The last minute counts down in seconds.

At the end of the cooking process the steam generator will switch off. A buzzer or a melody will sound (see "Settings - Acoustic information"). Steam Reduction (only with temperatures of approx. 175°F / 80°C) and Program Finished will appear in the display.

You have the option to save the program as a Favorite (see "Favorites") or to increase the cooking duration using Change. Tap "Back" to go back to the main menu.

Operation: Steam cooking

Changing settings during a cooking process

- Select Change.

The following will appear on the display:

- Temperature
- Duration
- Ready at
- Start at

If the temperature in the oven is too high Ready at and Start at are not displayed.

- Change Mode

Changing the temperature

- Select Temperature.
- Change the temperature.
- Confirm with OK.

The cooking program will restart with the new temperature.

You can also permanently reset the recommended temperature to suit your personal cooking habits (See "Settings - Recommended Temperatures").

Changing the cooking duration

- Select Duration.
- Change the duration.
- Confirm with OK.

The program will restart using the new duration.

Deleting a finish time

- Select Ready at.
- Select Reset.

The finish time is now deleted.

The program will start using the duration set.

Changing the oven mode

- Select Change Mode.
- Select the desired mode.

The new mode will appear on the display together with its recommended temperature.

- Change the temperature, if necessary.
- Confirm with OK.
- Set a different cooking duration if necessary.
- Confirm with OK.

The oven mode has been changed.

Canceling cooking

- Select ↶.

Cancel Cooking? appears on the display.

- Select Yes.

The Main Menu will appear. Any cooking durations set will be deleted.

Operation: Combination cooking mode

Combi Steam works by combining dry heat and steam. You can combine up to ten cooking stages in a combination mode program. You can set the temperature, moisture level, and duration or core temperature (when using the roast probe) for each cooking stage.

The cooking program will be carried out in the order in which the individual stages are entered.

The following operating modes are available:

- Convection Bake
- Surround
- Maxi Broil

The roast probe cannot be used with Maxi Broil.

You cannot cook with a core temperature after a cooking stage using Maxi Broil.

Operation: Combination cooking mode

A fault can occur if the drain is blocked.

Check that the drain filter is correctly in place before each program as large food residues can clog the drain.

Quick guide

The following example describes a cooking program with 3 cooking stages.

- Turn the steam oven on ①.

The main menu appears on the display.

Only use cold tap water (less than 68°F / 20°C). Never use distilled or mineral water or other liquids.

- Fill the water container and push it back in so that it engages.
- Insert the roast probe if required into the food (see "Roast probe").
- Put the food in the oven.
- When cooking on the rack, insert the universal tray underneath it.
- Select Betriebsarten.
- Select Combigaren.

Cooking stage 1

Convection Bake / Surround

- Set the required temperature.
- Confirm with OK.
- Set the required moisture.
- Confirm with OK.
- Select Set the Duration or Set Core Temperature.
- Set the cooking duration or core temperature. Any time between 1 minute and 12 hours can be set.
- Confirm with OK.
- Select Add Cooking Stage.

Maxi Broil

- Set the broil level.
- Confirm with OK.
- Set the required moisture.
- Confirm with OK.
- Set the cooking duration. Any time between 1 minute and 6 hours can be set.
- Confirm with OK.
- Select Add Cooking Stage.

Cooking stage 2

- Select the desired mode.
- Select the required settings (see cooking stage 1).
- Confirm with OK.
- Select Add Cooking Stage.

Cooking stage 3

- Select the desired mode.

Operation: Combination cooking mode

- Select the required settings (see cooking stage 1).
- Confirm with OK.
- Select Complete Combi Steam.

A summary of your settings will appear on the display.

- Check the settings and confirm with **Accept** or select **Change** to correct the settings or to add further cooking stages.

When you have confirmed the settings, the following will appear in the display:

- Start Now
- Save
- Ready at
- Start at

A Ready at time cannot be entered if you are using the roast probe. When using the roast probe, the end of the cooking duration is determined by when the set core temperature is reached. Only Start Later can be selected.

- Change Cooking Stages
- If you wish to save your settings as a user program select **Save** and enter a program name (see "User programs").
- Start the cooking process immediately or alter further settings as necessary (see "Additional functions").

At the end of the cooking duration

- Steam Reduction (only with temperatures of approx. 175-210°F / 80-100°C and a 100% humidity setting) and Program Finished will appear in the display.
- The fan remains on.
- A buzzer or melody will sound (see "Settings - Acoustic information").

You have the option to save the program as a Favorite (see "Favorites") or to increase the cooking duration using **Change**. Tap **Back** to go back to the main menu.

Burn hazard!

You could burn yourself on the oven interior walls, spilled food and accessories

Use pot holders when removing hot food from the oven.

- Wait until Steam Reduction goes out on the display before opening the door and removing the food.

Operation: Combination cooking mode

After use

- Remove and empty the water container and condensate container. Push upwards slightly as you take them out of the appliance.
- Turn the steam oven off ①.

Following a cooking program with steam, **Appliance Rinsing** will appear in the display after the steam oven has been switched off.

This process should be carried out every time to flush any remaining food deposits out of the system.

- Follow the instructions on the display
- After each use, clean and dry the whole appliance as described in "Cleaning and care."
- Leave the appliance door open until the oven interior is completely dry.

Insufficient water

If the steam oven runs out of water during operation, an audible tone will sound and the display will prompt you to fill the water container with fresh tap water.

- Remove the water container and fill it with fresh tap water.
- Push the water container into the appliance until it connects.
- Close the door.

Operation will continue.

Interrupting operation

Operation is interrupted as soon as the door is opened. The heating will be turned off and the cooking duration remaining stored in memory.

 Burn hazard!

Steam can escape when the door is opened.

Step back and wait until the steam has dissipated.

 Burn hazard!

You could burn yourself on the oven interior walls, spilled food and hot steam.

Use pot holders when inserting, removing or turning hot food, or when adjusting shelves, etc. in a hot oven.

Operation will resume when the door is closed.

The oven will heat up again and the display will show the temperature of the cooking compartment as it rises. Once the set temperature has been reached, the display will change to show the cooking duration remaining as it counts down.

For cooking processes with a 100% humidity setting and temperatures up to 210°F / 100°C:

The cooking process will be ended early if the door is opened during the last minute of cooking (55 seconds standing time).

Operation: Combination cooking mode

Additional functions

Setting additional durations

You have placed the food in the oven and selected the settings for the cooking process.

You can set the program to turn off or on and off automatically by entering Ready at or Start at.

– Ready at

You specify the time you want cooking to stop.

– Start at

You specify the time you want cooking to start.

Cooking results can be impaired if there is a long delay between the food being placed in the oven and the start of cooking. Fresh food can change its color and even deteriorate.

If the temperature in the oven is too high, e.g. directly after another program, you will not be able to use this function. Ready at and Start at will not appear on the display if this is the case. Open the oven door until the appliance has cooled down.

A Ready at time cannot be entered if you are using the roast probe. When using the roast probe, the end of the cooking duration is determined by when the set core temperature is reached. Only Start Later can be selected.

Turning on and off automatically

To turn a cooking program on and off automatically, you have a choice of how to enter the time parameters:

– Duration and Ready at

– Duration and Start at

Example: It is now 11:45 am. The food takes 5 minutes to cook and needs to be ready at 12:30 pm.

■ In cooking stage 1, set a cooking duration of 5 minutes (see "Quick guide").

When you have selected the settings for the cooking process:

■ Select Ready at and set "12:30."

■ Confirm with OK.

Start at is calculated automatically.

Start at 12:25 appears on the display. The cooking process will start automatically at this time.

Operation: Combination cooking mode

Sequence of an automatic cooking process

Up until the start time the function, the selected temperature and moisture level, Start at and the start time will appear in the display.

After the start time during the preheating phase you can follow the temperature increasing in the display. When the required temperature is reached a buzzer or a melody will sound (see "Settings - Acoustic information").

After the preheating phase you can follow the time counting down in the display. The last minute counts down in seconds.

At the end of the cooking process the steam generator and oven compartment lighting will switch off. A buzzer or a melody will sound (see "Settings - Acoustic information").

Steam Reduction (only with temperatures of approx. 175-210°F / 80-100°C and a 100% humidity setting) and Program Finished will appear in the display.

You have the option of saving the program as a user program (see "User programs"). Tap "Back" to go to the main menu.

Changing settings during a cooking process

- Select Change.

The following will appear on the display:

- all individual cooking stages
- Add Cooking Stage

The setting specified for a cooking stage can be changed or more cooking stages can be added to the program.

- Select the desired cooking stage or Add Cooking Stage.
- Alter the cooking stages as you wish (see "Simple operation") and confirm with OK.

A summary of your settings will appear on the display.

- Check the settings and confirm with Accept or select Change to correct the settings or to add further cooking stages.

Canceling cooking

- Tap "Back".

Cancel Cooking? appears on the display.

- Select Yes.

The list of operating modes will appear. Any cooking durations set will be deleted.

If you tap ↵ again, the main menu will appear.

Operation: Functions without steam

You do not necessarily need to enter a cooking duration for operating modes which do not use steam. If no duration is entered, operation starts automatically as soon as the temperature has been confirmed or after 15 seconds. The steam oven will switch off automatically after a maximum 12 hours of operation, or after a maximum 6 hours for grill modes.

If a cooking duration is entered, it starts to count down when the preheating phase begins.

You can choose to inject steam. The steam will be injected as soon as you have selected this option,  will appear in the display. It takes about 1 minute. There is no limit to the number of times you can inject a burst of steam.

The following operating modes are available:

- Convection Bake
- Surround
- Intensive
- Bake
- Browning
- Maxi Broil
- Broil
- Convection Broil
- Humidity Plus
- Gentle Bake

The roast probe cannot be used with the Maxi Broil and Broil modes.

Operation: Functions without steam

The grease filter on the back wall must be removed for baking as this can result in uneven browning.

- After each use, clean and dry the whole appliance as described in "Cleaning and care."
- Turn the steam oven off ①.
- Leave the appliance door open until the oven interior is completely dry.

Quick guide

- Remove the grease filter from the back wall
- Turn the steam oven on with ①.

The main menu appears on the display.

- If you wish to cook with bursts of steam, fill the water container and push it back in so that it engages.
- Insert the roast probe if required into the food (see "Roast probe").
- Put the food in the oven.
- Select Operating Modes.
- Select the desired mode.
- Change the recommended / core temperature or broil level if necessary.
- Confirm with OK.

The recommended temperature will be automatically accepted within a few seconds.

If required, select **Change | Temperature** to go back to the temperature selection option.

The cooking program will start. The oven heating, lighting, and fan will switch on.

- Set additional settings as necessary, e.g. setting a cooking duration (see "Advanced functions").

After cooking

- Remove the food from the oven.

Operation: Functions without steam

Interrupting operation

Operation is interrupted as soon as the door is opened. The heating will be switched off.



Burn hazard!

You could burn yourself on the oven interior walls, spilled food and accessories

Use pot holders when inserting, removing or turning hot food, or when adjusting shelves, etc. in a hot oven.

Operation will resume when the door is closed.

The steam oven will heat up again and the display will show the temperature in the oven compartment as it rises.

Operation: Functions without steam

Additional functions

You have placed the food in the oven, selected a function, and set the temperature or broil level.

■ Select Change.

Additional menu items will appear. You can select or change these options for the cooking program:

- Duration
- Ready at

A Duration and Ready at time cannot be entered if you are using the roast probe. When using the roast probe, the end of the cooking duration is determined by when the set core temperature is reached.

- Start at

Only appears when either Duration or Ready at have been set or if you are using the roast probe.

- PreHeating

Only appears if you have set a temperature of more than 210°F / 100°C in Convection Bake and Surround.

- Change Mode

Setting additional durations

By entering Duration, Ready at or Start at you can automatically turn the cooking program on or off.

- Duration

Enter the cooking duration required. You can select a duration of between 1 minute and 12 hours, or 1 minute and 6 hours for grill modes.

- Ready at

You specify the time you want cooking to stop.

- Start at

You specify the time you want cooking to start.

When baking, the oven should not be set to start a long time off. Otherwise the cake mixture or dough will dry out, and the raising agents will lose their effectiveness.

Cooking results can be impaired if there is a long delay between the food being placed in the oven and the start of cooking. Fresh food can change its color and even deteriorate.

Operation: Functions without steam

Turning off automatically

To switch off a cooking process automatically, you can set either **Garzeit** or **Fertig um**.

Example: It is now 11:45 am. The food takes 30 minutes to cook and needs to be ready at 12:15 pm.

- Select **Change**.
- Select **Garzeit** and set "00:30."
- Confirm with **OK**.

or

- Select **Change**.
- Select **Ready at** and set "12:15."
- Confirm with **OK**.

The oven will switch off automatically after this duration has elapsed or the time set has been reached.

Turning on and off automatically

We recommend using automatic switch-on and switch-off when roasting.

To turn a cooking program on and off automatically, you have a choice of how to enter the time parameters:

- **Duration** and **Ready at**
- **Duration** and **Start at**
- **Ready at** and **Start at**

Example: It is now 11:30 am. The food takes 30 minutes to cook and needs to be ready at 12:30 pm.

- Select **Change**.
- Select **Duration** and set a duration of "00:30."
- Confirm with **OK**.
- Select **Ready at** and set "12:30."
- Confirm with **OK**.

Start at is calculated automatically.

Start at 12:00 appears on the display. The cooking process will start automatically at this time.

Operation: Functions without steam

Sequence of an automatic cooking process

Up until the start time the function, the selected temperature, Start at and the start time will appear in the display.

After the start time during the preheating phase you can follow the temperature increasing in the display. When the required temperature is reached a buzzer or a melody will sound (see "Settings - Acoustic information").

After the preheating phase you can follow the time counting down in the display. The last minute counts down in seconds.

At the end of the cooking process the oven compartment heating will switch off. A buzzer or melody will sound (see "Settings - Acoustic information").

Program Finished will appear in the display.

You have the option to save the program as a Favorite (see "Favorites") or to increase the cooking duration using Change. Tap "Back" to go back to the main menu.

Rapid PreHeat

"Rapid PreHeat" can be used to speed up the preheating phase.

This function switches on automatically if you set the temperature above 210°F / 100°C for Convection Bake and Surround.

Rapid heat-up should be switched off when cooking pizza and delicate items (e.g. sponge or pastry). These will get brown too quickly on the top.

You can switch off Rapid PreHeat for a relevant cooking process via the Pre-Heating option.

Menu option PreHeating

- Rapid

The Browning / Broiling and convection heating elements turn on together with the fan to enable the steam oven to reach the required temperature as quickly as possible.

- Normal

Only the heating elements associated with the cooking mode are turned on.

Operation: Functions without steam

Switching off Rapid PreHeat

- Select Change.
- Select PreHeating.
- Select Normal.
- Confirm with OK.

Rapid PreHeat has been switched off.
PreHeating appears in the display.

Changing the oven mode

You can change the oven mode during operation.

- Select Change.
- Select Change Mode.
- Select the desired mode.

The new mode will appear on the display together with its recommended temperature.

Any cooking durations set will be adopted. Exception: If you change to Steam Cooking or Combi Steam, you must enter another duration.

- Change the temperature and/or cooking duration if necessary.
- Confirm with OK.

The oven mode has been changed.

Changing settings during a cooking process

- Select Change.

The following will appear on the display:

- Temperature or Broil Setting
- Duration
- Core Temp.

This option only appears when you are using the roast probe.

- Ready at

A Duration and Ready at time cannot be entered if you are using the roast probe. When using the roast probe, the end of the cooking duration is determined by when the set core temperature is reached.

- Start at

Only appears if you have set Duration or Ready at or when using the roast probe.

- PreHeating

Only appears if you have set a temperature of more than 210°F / 100°C in Convection Bake and Surround.

- Change Mode

Operation: Functions without steam

Changing the temperature

- Select Temperature.
- Change the temperature.
- Confirm with OK.

The steam oven will be heated up or cooled down until the altered temperature is reached.

You can also permanently reset the default temperature to suit your personal cooking habits (See "Settings - Default temperatures").

Changing the core temperature

- Select Core Temp.
- Change the core temperature.
- Confirm with OK.

Changing the broil level

- Select Broil Setting.
- Change the level.
- Confirm with OK.

The program will restart with the new broil level.

Changing the cooking duration

- Select Duration.
- Change the duration.
- Confirm with OK.

The program will restart using the new duration.

Deleting a cooking duration

- Select Duration.
- Select Reset.

The program will continue with the set temperature.

Deleting a finish time

- Select Ready at.
- Select Reset.

The finish time is now deleted.

The program will start using the duration set.

Canceling cooking

- If you have not set a cooking duration, tap "Back".

The main menu will appear.

- If you have set a cooking duration or are using the roast probe, tap "Back".

Cancel Cooking? appears on the display.

- Select Yes.

The main menu will appear. Any cooking durations or core temperature set will be deleted.

MasterChef

Your steam oven has a number of MasterChef programs that enable you to achieve excellent cooking results with ease. Simply select the appropriate program for the type of food you are cooking and follow the instructions on the display.

List of automatic programs

The programs can be found under MasterChef.

- Vegetables
- Fish
- Meat
- Bread
- Rolls
- Cakes/Pastries
- Pizza & Quiche
- Rice
- Grain
- Pasta
- Legumes
- Eggs
- Fruit
- Mushrooms
- Sausage
- Shellfish
- Mussels
- Special

Using the MasterChef programs

- Select MasterChef.

A list of food types will appear on the display.

- Select the desired food category.

The MasterChef programs available for the food category selected will appear.

- Select the desired MasterChef program.

Each step you need to take before starting the MasterChef program will appear on the display.

In some programs, you will be prompted on when to add food to the oven. Follow and confirm these instructions.

Notes on using these programs

- The degree of doneness and browning levels are represented by a bar with seven segments. The factory setting is a medium doneness and browning. It will be highlighted. To change the setting simply move the highlighting to the left or the right.
- The weights shown refer to the weight per piece. You can cook a piece of salmon with a weight of ½ lb (250 g) or 10 pieces of salmon with a weight of ½ lb (250 g) at the same time.
- The oven interior needs to be at room temperature before starting a MasterChef program.
- When placing food in an already hot steam oven, be very careful when opening the door. Hot steam can es-

cape. Step back from the steam oven and wait until the steam has dissipated. When putting cooking pans or the drip tray into the oven or taking them out, take care not to spill the contents. Avoid contact with hot steam, and do not touch the hot oven interior walls. Danger of burning and scalding.

- Please refer to recipes for information on suitable baking containers.
- For some MasterChef programs, the start time can be delayed using Start at or Ready at.
- To end a MasterChef automatic program early, turn the steam oven off completely by touching "Back".
Cancel Cooking? will appear on the display. If Yes is selected, the main menu will be shown again.
- If the food is not cooked enough by the end of an MasterChef program, select Cont. Cooking or Continue Baking.
- MasterChef programs can also be saved as Favorites.

Favorites

You can create and save up to 20 of your own programs.

- Each one can have up to 10 cooking stages. This enables you to save your favorite or most frequently used recipes very accurately. You can make individual settings for each stage.
- You can enter a program name for your recipe.

When you next select the program, it will start automatically.

There are different ways of creating a Favorite:

- At the end of running a MasterChef Program, save it as a separate program.
- After running a program with a set duration, select Save.

Then name the program.

Creating a Favorite

- Select Favorites.

When first creating a program, Create Program will appear on the display.

- Confirm with OK.

If the Favorite already exists, the program name will appear with Edit Program underneath.

- Select Edit Program.
- Select Create Program.

You can now specify the settings for cooking stage 1.

Follow the instructions on the display:

- Select and confirm the cooking mode, temperature, broil level, the moisture level if necessary, and the duration or core temperature.

With Convection Bake and Surround you can specify whether you wish to use Rapid PreHeat for this cooking stage via Additional Parameters (see "Operation: Functions without steam - Rapid PreHeat").

The settings for the first cooking stage have now been set.

You can add more cooking stages, for example, if you want to add another cooking mode to follow on from the first:

- Select Add Cooking Stage and proceed as for the first cooking stage.
- When you have completed setting the cooking stages. select Complete Program.

A summary of your settings will appear on the display.

- Check the settings and confirm with **Accept** or select **Change** to correct the settings or to add further cooking stages.
- Select **Save**.
- Enter the program name.

The following symbols appear next to the alphabet:

Sym- bol	Description
_	Space
ABC	Alphabet in upper case
abc	Alphabet in lower case
123	Numbers 0 to 9 and hyphen -

- Touch the sensors next to the symbols to highlight the desired character.
- Select **Select**.

The letter or number you have selected will appear in the top line of the display.

A maximum of 10 characters can be used.

You can delete the characters one at a time with "Back".

- Finish creating the program name.
- Once you have entered the program name select **Save**.

A message will appear in the display confirming that the program has been saved.

- Confirm with **OK**.

You can start the saved program immediately, delay the start or change the cooking stages.

More information regarding **Change Cooking Stages** can be found in "Changing favorites".

Favorites

Starting a Favorite

- Put the food in the oven.
- Select Favorites.

The display shows the program names and Edit Program at the bottom.

- Select the desired program.

You can start the saved program immediately, delay the start or change the cooking stages.

- Start Now

The program will start. The oven compartment lighting and the steam generator will switch on immediately.

- Start Later

This option only appears if you are using the roast probe. You can specify when you want the program to start.

- Ready at

You can set the time at which the cook program should end.

- Start at

You can set the time at which the cooking program should start.

- Change Cooking Stages

The setting specified for a cooking stage can be corrected (see "Changing favorites") or more cooking stages can be added to the program.

- Select the desired mode.

The program will start according to the specified start or finish time.

Changing Favorites

Changing cooking stages

Cooking stages in a MasterChef program that have been saved under a different name cannot be changed.

- Select Favorites.

The display shows the program names and Edit Program at the bottom.

- Select the desired program.

- Select Change Cooking Stages.

The setting specified for a cooking stage can be changed or more cooking stages can be added to the program.

- Select the desired cooking stage or Add Cooking Stage.
- Change the program as desired (see "Creating favorites") and confirm by touching OK.

A summary of your settings will appear on the display.

- Check the settings and confirm with Accept.
- Select Save.
- If necessary, change the name (see "Creating favorites") and select Save.

A message will appear in the display confirming that the program has been saved.

- Confirm with OK.

Changing the name

- Select Favorites.

The display shows the program names and Edit Program at the bottom.

- Select Edit Program.
- Select Change Program.
- Select the desired program.
- Select Change Name.
- Change the name (see "Creating a Favorite") and select Save.

A message will appear in the display confirming that the program has been saved.

- Confirm with OK.

Deleting a Favorite

- Select Favorites.

The display shows the program names and Edit Program at the bottom.

- Select Edit Program.
- Select Delete Program.
- Select the desired program.
- If you wish to delete the program, confirm with Yes.

The program is deleted.

You can delete all of your Favorites at the same time (see "Settings - Factory Default - Favorites").

Timer

The timer can be used to time any activity in the kitchen, e.g. boiling eggs.

The timer can also be used at the same time as a cooking program if a start and finish time have been set, e.g. a reminder to stir the dish or add seasoning.

A maximum timer duration of 9 hours, 59 minutes and 59 seconds can be set.

Setting the timer

If you want to use the timer and Time | Show | Off has been set, you will need to switch the steam oven on before you can set the timer. The timer can then be seen counting down on the display when the steam oven is switched off.

Example: You are boiling eggs so you set the timer for 6 minutes and 20 seconds.

- Tap "Timer".

"0 : 00 : 00" (h : min : sec) will appear on the display.

- Use the numeric keypad to enter a different duration (6-2-0).
- Confirm with OK.

The duration counts down on the display when the steam oven is turned off.

If a cooking program is running at the same time, the timer duration will appear at the bottom of the display.

At the end of the timer

- "Timer" flashes in the display.
- The time starts counting upwards.
- A buzzer or melody will sound (see "Settings - Acoustic tone information").
- Select "Timer" or the illuminated sensor button next to the timer to turn off the acoustic and optical signals.

Resetting the timer

- Tap "Timer" or the illuminated sensor button next to the timer duration that is counting down.

The set timer appears on the display.

- Set the new timer duration using the numeric keypad.
- Confirm with OK.

The altered timer duration will start to count down immediately.

Canceling the timer

- Tap "Timer" or the illuminated sensor button next to the timer duration that is counting down.

The set timer appears on the display.

- Select **Reset**.

The timer duration is now cancelled.

The "General Notes" section contains general information. You will find more detailed information about particular foods and how to cook them in the other sections.

The advantages of cooking with steam

Almost all vitamins and minerals are retained as the food is not immersed in water.

Cooking with steam also retains the true taste of the food better than conventional cooking. We therefore recommend seasoning the food after it has been cooked. Food also retains its fresh, original color.

Suitable containers

Cooking pans

This steam oven is supplied with stainless steel cooking pans. Other containers, in a variety of sizes, both perforated and solid, are available as optional extras (see "Optional accessories"). This enables you to choose the most suitable container for the food you are preparing.

It is best to use perforated pans for **Steam Cooking**. The steam can reach the food from all sides and the food is cooked evenly.

Your own pans

You can also use your own pans. However, please note the following:

- The pan must be suitable for using in an oven and must be steam resistant. Plastic pans can only be used for steam cooking if the manufacturer has stated that they are suitable for such use.
- Thick-sided pans made from porcelain, china or stoneware, for example, are not so suitable for steam cooking. They do not conduct heat well and as a result cooking durations will be considerably longer than those given in the charts.
- Place the cooking pans on the rack or on a suitable tray and not on the oven floor.
- Ensure that there is a gap between the upper rim of the container and the top of the cooking compartment to allow sufficient steam into the container.

General notes

Shelf level

You can select any shelf level. You can also cook on several levels at the same time. This will not alter the cooking duration.

When using more than one deep pan at the same time, it is best to offset them on their runners and to leave at least one level free in between them.

Always insert cooking pans and the rack between the rails of the shelf level supports so that they cannot tip.

Frozen food

The heating up phase for frozen food is longer than for fresh food. The greater the quantity of frozen food, the longer the preheating phase.

Temperature

A maximum temperature of 210°F / 100°C is reached when steam cooking is taking place. Most types of food will cook at this temperature. Some more delicate types of food, such as soft fruit, must be cooked at lower temperatures as otherwise they will burst. More information is given in the relevant section.

Cooking duration

In general, the cooking durations for Steam Cooking are the same as for cooking food in a saucepan. More information about any factors which may affect the cooking duration is given in the relevant sections.

The quantity of food does not affect the cooking duration. 1 lb of potatoes will take the same time to cook as ½ lb.

The durations given in the charts are guidelines only. We recommend selecting the shorter cooking duration quoted to start with. If food is not cooked sufficiently after the shorter time it can be put back in the oven and cooked for longer.

Cooking with liquid

When cooking with liquid only fill the cooking pan $\frac{2}{3}$ full to prevent the liquid spilling when the cooking pan is removed from the oven.

Your own recipes - Steam cooking

Food and recipes which are prepared in pot or a pan can also be cooked in the steam oven. The cooking times in the steam oven will be the same. Please note that food will not be brown or crisp when cooking with steam.

Wire oven rack / universal tray

Use the rack above the universal tray when roasting or broiling. The cooking liquids will collect in the tray and can then be used to make a gravy or sauce.

If you are using the universal tray with the rack on top, e.g. for broiling, insert the tray between the rails of the side runners and the rack will automatically slide in above them. When removing them from the oven pull both parts out together.

Non-tip safety notches

The wire oven rack and universal tray have non-tip safety notches in the middle which prevent them being pulled right out when they only need to be partially pulled out. The tray and rack can then only be taken out of the oven by raising them upwards and then pulling them out.

Steam cooking

Vegetables

Fresh food

Prepare fresh vegetables in the usual way, i.e. wash, clean and cut them up.

Frozen food

Frozen vegetables do not need to be defrosted beforehand unless the vegetables have been frozen together in a block.

To cook frozen vegetables, program the same time as for fresh ones.

Break up the larger, frozen together pieces. Please refer to the cooking times on the packaging.

Cooking pan

Food such as peas or asparagus spears, which have little or no space between them, will take longer to cook because the steam has less space to work in. For an even result, it is best to use a shallow container for these types of food, and only fill it about 1-2" (3-5 cm) deep. When cooking large quantities divide the food between 2 or 3 shallow containers rather than using one deep one.

Different types of vegetables which take the same length of time to cook can be cooked together in one cooking pan.

Use solid containers for vegetables which are cooked in liquid, e.g. cabbage.

Shelf level

When cooking vegetables with a distinctive color (e.g. beets) in a perforated container at the same time as cooking other foods in other containers, place the drip tray directly underneath the perforated container to catch any drips and therefore avoid any color transfer.

Cooking duration

As with conventional methods, when cooking vegetables with steam, the cooking duration will depend on the size and also whether you want the vegetables to be al dente or soft/well done. Example:

firm potatoes, cut into quarters
= approx. 17 minutes
firm potatoes, cut in half
= approx. 21 minutes

Settings

MasterChef | Vegetables | ... | Steam Cooking

or

Operating Modes | Steam Cooking
Temperature: 210°F / 100°C
Duration: see chart

Steam cooking

The durations given in the charts for fresh vegetables are guidelines only. We recommend selecting the shorter cooking duration quoted to start with. If vegetables are not cooked sufficiently after the shorter time, they can be put back in the steam oven and cooked some more.

Vegetables	🕒 [min]
Artichokes	32–38
Cauliflower, whole	27–28
Cauliflower, florets	8
Beans, green	10–12
Broccoli, florets	3–4
Carrots, whole	7–8
Carrots, halved	6–7
Carrots, chopped	4
Chicory, halved	4–5
Chinese cabbage, chopped	3
Peas	3
Fennel, halved	10–12
Fennel, cut into strips	4–5
Kale, chopped	23–26
Waxy potatoes, peeled	
whole	27–29
halved	21–22
quartered	16–18
Fairly waxy potatoes, peeled	
whole	25–27
halved	19–21
quartered	17–18
Floury potatoes, peeled	
whole	26–28
halved	19–20
quartered	15–16
Kohlrabi, cut into sticks	6–7

Steam cooking

Vegetables	 [min]
Pumpkin, diced	2–4
Corn on the cob	30–35
Swiss chard, chopped	2–3
Peppers, diced / cut into strips	2
Potatoes cooked in skins, firm	30–32
Mushrooms	2
Leeks, chopped	4–5
Leek, halved lengthwise	6
Romanesco, whole	22–25
Romanesco, florets	5–7
Brussels sprouts	10–12
Red beets, whole	53–57
Red cabbage, chopped	23–26
Black salsify, whole	9–10
Celery root, cut into batons	6–7
Green asparagus	7
White asparagus, whole	9–10
Carrots, chopped	6
Spinach	1–2
Pointed cabbage, chopped	10–11
Celery, chopped	4–5
Rutabaga, chopped	6–7
White cabbage, chopped	12
Savoy cabbage, chopped	10–11
Zucchini, sliced	2–3
Snap peas	5–7

 Cooking duration

Meat

Fresh food

Prepare the meat as usual.

Frozen food

Meat should be thoroughly defrosted before cooking in the steam oven (see "Defrosting").

Preparation

For meat which needs to be seared before being cooked, e.g. for a stew, sear the meat in a pan on the cooktop first.

Cooking duration

The cooking time depends on the thickness and consistency of the food. The thicker the meat, the longer the cooking time.

Tips

- Use a perforated pan to retain the **flavor** when cooking meat. Place a solid pan or universal tray underneath to catch the juices. You can use these to make a gravy or freeze them for later use.
- Boiling chicken, pork rind, meat, ribs and meat bones can be used to make **stock**. Place the meat together with some mixed vegetables in a solid cooking pan and add cold water. The longer the cooking duration, the stronger the stock.

Settings

MasterChef | Meat | ... | Steam Cooking

or

Operating Modes | Steam Cooking

Temperature: 210°F / 100°C

Duration: see chart

Steam cooking

The cooking times given in the chart are guidelines only. We recommend selecting the shorter cooking time to start, additional time can be added if necessary.

Meat	🕒 [min]
Shank, covered with water	110–120
Pork knuckle	135–140
Chicken breast filet	8–10
Leg (Joint)	105–115
Prime rib, covered with water	110–120
Veal strips	3–4
Smoked pork chops	6–8
Lamb stew	12–16
Spring chicken	60–70
Roulade of turkey	12–15
Turkey breast	4–6
Cross rib, covered with water	130–140
Beef stew	105–115
Whole chicken, covered with water	80–90
Boiled beef	110–120

🕒 Cooking duration

Sausage

Settings

MasterChef | Sausage | ... | Steam Cooking
or

Operating Modes | Steam Cooking
Temperature: 194°F / 90°C
Duration: see chart

Sausage	🕒 [min]
Boiled sausage	6–8
Pork sausage	6–8
Veal sausage	6–8

🕒 Cooking duration

Fish

Fresh food

Prepare fresh fish in the usual way, i.e. clean, gut and filet.

Frozen food

Frozen fish should be slightly defrosted before cooking.

Preparing for use

Add some lemon or lime juice to fish before cooking. The citric acid helps the flesh stay firm.

It is not necessary to season fish when cooking with steam as this method retains the minerals which give the fish its unique flavor.

Cooking pans

If using a perforated pan, grease it first.

Shelf level

When cooking fish in a perforated container at the same time as cooking other types of food in other containers, place the container with the fish directly above the tray to catch any liquid and so avoid any transfer of tastes to other food.

Steam cooking

Temperature

185° F – 195° F / 85° C – 90° C

For gently cooking delicate types of fish, such as sole.

212° F / 100° C

For cooking firmer types of fish, e.g. cod and salmon.

Also for cooking fish in sauce or stock.

Cooking duration

The cooking duration depends on the thickness and the consistency of the food, and not on the weight.

The longer fish cooks, the firmer its flesh will become. Use the cooking durations given in the chart. If you find that the fish is not cooked sufficiently only cook it for a few minutes more.

When cooking fish in sauce or stock, we recommend that you increase the cooking duration quoted by a few minutes.

Tips

- Adding herbs and spices, such as dill, will help bring out the full flavor of the fish.
- Cook large fish in the swimming position. To help maintain the shape of the fish, place a small cup or similar upside down in the cooking pan, and arrange the fish bellyside down over the cup.

- You can use any fish scraps, e.g. fish heads, bones, tails etc to make a **fish stock**. Place the fish scraps together with some mixed vegetables in a solid cooking pan and add cold water. Cook at 212°F / 100°C for 60 to 90 minutes. The longer the cooking duration, the stronger the stock.

Settings

MasterChef | Fish | ... | Steam Cooking

or

Operating Modes | Steam Cooking

Temperature: see chart

Duration: see chart

Steam cooking

The durations given in the chart are guidelines for fresh fish. We recommend selecting the shorter cooking duration quoted to start with. If the fish is not cooked sufficiently after the shorter time, it can be put back in the steam oven and cooked some more.

Fish	🌡️ [°F / °C]	🕒 [min]
Eel	212 / 100	5–7
Perch filet	212 / 100	8–10
Mahi Mahi filet	185 / 85	3
Trout, 1/2 lb (250 g)	195 / 90	10–13
Halibut filet	185 / 85	4–6
Cod filet	212 / 100	6
Carp, 3 lbs (1.5 kg)	212 / 100	18–25
Salmon filet	212 / 100	6–8
Salmon steak	212 / 100	8–10
Rainbow trout	195 / 90	14–17
Pangasius filet	185 / 85	3
Ocean Perch filet	212 / 100	6–8
Haddock filet	212 / 100	4–6
Flounder filet	185 / 85	4–5
Monkfish filet	185 / 85	8–10
Sole filet	185 / 85	3
Turbot filet	185 / 85	5–8
Tuna filet	185 / 85	5–10
Pike Perch filet	185 / 85	4

🌡️ Temperature / 🕒 Cooking duration

Steam cooking

Shellfish

Preparation

Defrost frozen shellfish before cooking with steam.

Peel, clean and wash the shellfish.

Cooking pan

If using a perforated pan, grease it first.

Cooking duration

The longer shellfish are cooked, the tougher they become. Use the cooking durations given in the chart.

When cooking shellfish in sauce or stock, we recommend that you increase the cooking duration quoted by a few minutes.

Settings



MasterChef | Shellfish | ... | Steam Cooking

or

Operating Modes | Steam Cooking

Temperature: see chart

Duration: see chart

	 [°F / °C]	 [min]
Shrimp	195 / 90	3
Small shrimp	195 / 90	3
King prawns	195 / 90	4
Crayfish	200 / 95	10–15
Large shrimp	195 / 90	3

 Temperature /  Cooking duration

Mussels

Fresh food



Warning - danger of food poisoning.

Only cook mussels which are closed. Do not eat mussels which have not opened after being cooked.

Steep fresh mussels in water for a few hours before cooking to rinse out any sand. Then scrub the mussels thoroughly to clean them.

Frozen food

Defrost frozen mussels before cooking.

Cooking duration

The longer mussels are cooked, the tougher they become. Use the cooking durations given in the chart.

Settings



MasterChef | Mussels | ... | Steam Cooking

or

Operating Modes | Steam Cooking

Temperature: see chart

Duration: see chart

	 [°F / °C]	 [min]
Barnacles	212 / 100	2
Cockles	212 / 100	2
Bearded mussels	195 / 90	12
Scallops	195 / 90	5
Razor clams	212 / 100	2-4
Clams	195 / 90	4

 Temperature /  Cooking duration

Steam cooking

Rice

Rice swells when cooked and needs to be cooked in liquid. The proportion of rice to liquid will vary depending on the type of rice.

The rice absorbs all the liquid. Therefore none of the nutrients are lost.

Settings

MasterChef | Rice | ... | Steam Cooking

or

Operating Modes | Steam Cooking

Temperature: 210°F / 100°C

Duration: see chart

	Ratio Rice to liquid	🕒 [min]
Basmati rice	1 : 1.5	15
Parboiled rice	1 : 1.5	23–25
Round grain rice		
Pudding rice	1 : 2.5	30
Risotto rice	1 : 2.5	18–19
Brown rice	1 : 1.5	26–29
Wild rice	1 : 1.5	26–29

🕒 Cooking duration

Pasta

Dry pasta

Dry pasta swell when cooked and needs to be cooked in liquid. The liquid must cover the pasta. Using hot liquid gives better results.

Increase the cooking time stated by the manufacturer by approx. $\frac{1}{3}$.

Fresh food

Fresh noodles and pasta, for example, from the store refrigerator, do not swell. Fresh pasta should be cooked in a greased perforated pan.

Separate any pieces of pasta which have stuck together and spread them out in the cooking pan.

Settings

MasterChef | Pasta | ... | Steam Cooking

or

Operating Modes | Steam Cooking

Temperature: 210°F / 100°C

Duration: see chart

Fresh food	🕒 [min]
Gnocchi	2
Round Knoepfli	1
Ravioli	2
Spaetzle	1
Tortellini	2
Dry pasta, covered with water	
Flat pasta	14
Soup pasta	8

🕒 Cooking duration

Steam cooking

Dumplings

Ready-made dumplings in wrappers need to be covered completely with water. Otherwise they will not absorb enough water and will fall apart, even if steeped in water prior to cooking.

Cook fresh dumplings in a greased, perforated container.

Settings

MasterChef | Pasta | ... | Steam Cooking

or

Operating Modes | Steam Cooking

Temperature: 210°F / 100°C

Duration: see chart

	 [min]
Steamed dumplings	30
Yeast dumplings	20
Boil-in-the-bag potato dumplings	20
Boil-in-the-bag bread dumplings	18–20

 Cooking duration

Grains

Grain swells when cooked and needs to be cooked in liquid. The proportion of grain to liquid will vary depending on the type of grain.

Grain can be cooked whole or cracked.

Settings

MasterChef | Grain | ... | Steam Cooking

or

Operating Modes | Steam Cooking

Temperature: 210°F / 100°C

Duration: see chart

	Ratio Grain to liquid	🕒 [min]
Amaranth	1 : 1.5	15–17
Bulgur	1 : 1.5	9
Green spelt, whole	1 : 1	18–20
Green spelt, cracked	1 : 1	7
Oats, whole	1 : 1	18
Oats, cracked	1 : 1	7
Millet	1 : 1.5	10
Polenta	1 : 3	10
Quinoa	1 : 1.5	15
Rye, whole	1 : 1	35
Rye, cracked	1 : 1	10
Wheat, whole	1 : 1	30
Wheat, cracked	1 : 1	8

🕒 Cooking duration

Steam cooking

Legumes

Soak legumes for at least 10 hours in cold water before cooking. Soaking makes the legumes more digestible and shortens the cooking duration required. Soaked legumes must be covered with liquid during cooking.

Lentils do not need to be soaked before cooking.

With unsoaked legumes, a certain ratio of pulses to liquid is required depending on type.

Settings

MasterChef | Legumes | ... | Steam Cooking

or

Operating Modes | Steam Cooking

Temperature: 210°F / 100°C

Duration: see chart

Soaked	
	🕒 [min]
Beans	
Kidney beans	55–65
Azuki beans	20–25
Black beans	55–60
Pinto beans	55–65
White beans	34–36
Peas	
Yellow peas	40–50
Green peas, shelled	27

🕒 Cooking duration

Steam cooking

Unsoaked		
	Ratio Legumes to liquid	🕒 [min]
Beans		
Kidney beans	1 : 3	130–140
Azuki beans	1 : 3	95–105
Black beans	1 : 3	100–120
Pinto beans	1 : 3	115–135
White beans	1 : 3	80–90
Lentils		
Brown lentils	1 : 2	13–14
Red lentils	1 : 2	7
Peas		
Yellow peas	1 : 3	110–130
Green peas, shelled	1 : 3	60–70

🕒 Cooking duration

Steam cooking

Eggs

Use a perforated container to prepare boiled eggs in the steam oven.

The eggs do not need to be pierced before cooking as they are gradually warmed during the preheating phase and so do not burst when they are cooked with steam.

When using a solid container for making egg dishes such as scrambled eggs, remember to grease it first.

Settings

MasterChef | Eggs | ... | Steam Cooking

or

Operating Modes | Steam Cooking

Temperature: 210°F / 100°C

Fruit

Cook fruit in a solid container so that none of the juice is lost. If you wish to cook fruit in a perforated container, place a solid container directly underneath it to collect the juice.

Tip: You can use the collected juice to prepare a glaze.

Settings

MasterChef | Fruit | ... | Steam Cooking

or

Operating Modes | Steam Cooking

Temperature: 210°F / 100°C

Duration: see chart

	 [min]
Apple chunks	1–3
Pears chunks	1–3
Cherries	2–4
Mirabelle plums	1–2
Nectarine / Peach chunks	1–2
Plums	1–3
Quince, diced	6–8
Rhubarb pieces	1–2
Gooseberries	2–3

 Cooking duration

Steam cooking

Menu Cooking - Manual

Before cooking meals with the "Menu Cooking" function, turn off the steam reduction system (see "Settings").

"Menu Cooking" is intended for cooking a whole meal containing types of food which have different cooking durations, e.g., fish filet with rice and broccoli. Each dish is placed in the oven at different times so that they are all ready at the same time.

Shelf level

When cooking fish or food with a distinctive color (e.g. beetroot) in a perforated container, place the perforated container directly above the drip tray / universal tray (depending on model) to avoid any transfer of flavor or color to other food and to prevent liquid dripping onto food below it.

Temperature

Whole meals should be cooked at a temperature of 212°F / 100°C as this is the temperature required to cook the majority of foods.

Do not cook a whole meal at the lowest temperature when different temperatures are required for different types of food, e.g. 185°F / 85°C for seabream and 212°F / 100°C for potatoes.

If the recommended cooking temperature for the food is 185°F / 85°C, for example, try cooking it at 212°F / 100°C and testing the result. Some delicate types of fish with a soft structure, e.g. sole and plaice will become very firm when cooked at 212°F / 100°C.

Cooking duration

If you are increasing the recommended temperature, shorten the cooking duration by approx. $\frac{1}{3}$.

Example

Rice	20 minutes
Tilapia filet	6 minutes
Broccoli	4 minutes

20 minutes minus 6 minutes = 14 minutes (first cooking duration: rice)

6 minutes minus 4 minutes = 2 minutes (second cooking duration: tilapia filet)

Time left = 4 minutes (third cooking duration: broccoli)

Cooking durations	20 min. - rice		
	6 min. - tilapia filet		4 min. - broccoli
	14 min.		
Setting	14 min.	2 min.	4 min.

Method

- Switch off the steam reduction.
- Place the rice in the steam oven first.
- Set the first cooking duration: 14 minutes.
- After 14 minutes, place the tilapia in the steam oven.
- Set the second cooking duration: 2 minutes.
- After 2 minutes, place the broccoli in the steam oven.
- Set the third cooking duration: 4 minutes.

Sous-vide (vacuum) cooking

Always follow USDA guidelines on food safety.

This gentle cooking method allows food to be cooked slowly at a low, constant temperature in vacuum packaging.

With vacuum cooking, moisture does not evaporate and all nutrients and flavors are retained.

The result is flavorful and cooked evenly.

Only use food that is fresh and in good condition.

Ensure hygienic conditions and that food has not been out of the refrigerator too long, e.g. during transportation.

Use only heat-stable, boiling-resistant vacuum bags.

Do not cook food in the manufacturer's packaging, such as vacuum-packed frozen food. It is possible that an unsuitable vacuum bag was used.

Use the vacuum bag only once.

Vacuum-seal the food only with a sous-vide vacuum sealer that guarantees a full vacuum of 99.8%.

Sous-vide (vacuum) cooking

Important usage information

To obtain an optimum cooking result, observe the following information:

- Use less herbs and spices than for conventional cooking since the influence on the taste of the food is more intensive.
You can also prepare the food unseasoned and add seasonings after cooking.
- The cooking duration reduces when salt, sugar, and liquids are added.
- The food becomes firmer with the addition of acidic ingredients, such as lemon or vinegar.
- Do not use alcohol or garlic as an unpleasant taste may result.
- Only use vacuum bags that match the size of the food. If the vacuum bag is too big, too much air may remain inside.
- If you want to cook several foods in one vacuum bag, put the food in the bag one next to the other.
- If you want to cook several vacuum bags at once, put the bags on the shelf one next to the other.
- The cooking durations depend on the thickness of the food.
- In case of higher temperatures and/or longer cooking durations, a lack of water may occur. Check the display now and then.
- Keep the door closed during the cooking procedure. Opening the door extends the cooking process and can change the cooking result.

Tips

- Freeze liquids such as marinades before vacuum-sealing to prevent them from escaping from the vacuum bag.
- Fold the edges of the vacuum bag outwards for filling in order to obtain clean, perfect weld seams.
- If you do not want to eat the food directly after cooking, put it in an ice bath and then store it at a maximum of 37°F / 3°C. In this way, you can maintain quality and taste while extending the life of the food..
- After cooking, cut the vacuum bag on all sides to access the food better.
- Briefly sear meat and fish before serving.
- Serve the food on preheated plates.

Sous-vide (vacuum) cooking

Method

- Rinse the food with cold water and dry it.
- Put the food in a vacuum bag and add spices or liquid if desired.
- Vacuum-seal the food with the sous-vide vacuum sealer.
- For optimum cooking results, insert the rack on shelf level 2.
- Lay the vacuum-sealed food on the shelf (next to each other in the case of several bags).
- Select Operating Modes.
- Select Sous-vide.
- Adjust the recommended temperature if necessary.
- Confirm with OK.
- Set the cooking duration. Any time between 1 minute and 10 hours can be set.
- Confirm with OK.
- Select further settings if required (see "Operation: Steam cooking - Additional functions").

Possible causes for poor results

The vacuum bag opened:

- The seam was not clean or secure enough and dissolved.
- The bag was damaged by a sharp bone.

The food has an unpleasant or strange taste:

- The food was stored incorrectly.
- Your hands or counter were not perfectly clean.
- Too much spice was used.
- The bag or seam were damaged.
- The vacuum was insufficient.
- The food was not immediately eaten or cooled after cooking.

Sous-vide (vacuum) cooking

Food	Added in advance		🌡️ [°F / °C]	🕒 [min]
	Sugar	Salt		
Fish				
Cod filet, 1" (2.5 cm) thick		x	130 / 54	35
Salmon filet, 1 1/4" (3 cm) thick		x	125 / 52	30
Monkfish filet		x	145 / 62	18
Pikeperch filet, 3/4" (2 cm) thick		x	130 / 55	30
Vegetables				
Cauliflower florets, medium to large		x	185 / 85	40
Squash in slices		x	185 / 85	15
Kohlrabi in slices		x	185 / 85	30
Asparagus, white, whole	x	x	185 / 85	22–27
Sweet potatoes in slices		x	185 / 85	18
Fruit				
Pineapple in slices	x		185 / 85	167/75
Apple in slices	x		175 / 80	20
Bananas, whole			145 / 62	10
Peaches, halved	x		145 / 62	25–30
Rhubarb pieces			167/75	13
Plums, halved	x		160 / 70	10–12
Miscellaneous				
Beans, white, soaked at a 1:2 ratio (beans to liquid)		x	195 / 90	240
Shrimp, peeled and deveined		x	135 / 56	19–21
Egg, whole			149 - 151 / 65–66	60
Scallops, removed from shell			125 / 52	25

Sous-vide (vacuum) cooking

Food	Added in advance		🌡️ [°F / °C]	🕒 [min]
	Sugar	Salt		
Shallot, whole	x	x	185 / 85	45–60

🌡️ Temperature / 🕒 Cooking duration

Food	Added in advance		🌡️ [°F / °C]		🕒 [min]
	Sugar	Salt	Medium*	Well done*	
Meat					
Duck breast, whole		x	151 / 66	162 / 72	35
Rack of lamb			136 / 58	144 / 62	50
Beef tenderloin, 1 3/4" (4 cm) thick			133 / 56	142 / 61	120
Beef filet, 1" (2.5 cm) thick			133 / 56	–	120
Pork tenderloin, whole		x	145 / 63	153 / 67	60

🌡️ Temperature / 🕒 Cooking duration

* Degree of doneness

The "well done" degree of doneness has a higher core temperature than "medium," but is not cooked through in the traditional sense.

Reheat

Always follow USDA guidelines on food safety.

The steam oven is very effective at reheating food gently, without drying it out or cooking it further. The food reheats evenly and does not need to be stirred during the reheating process.

You can reheat individual dishes or plated meals which have been prepared previously (e.g. meat, vegetables and potatoes).

Suitable containers

Small quantities can be reheated on a plate, larger quantities should be placed in a cooking pan.

Duration

10-15 minutes are usually sufficient for one plate of food. More than one plate will need a little longer.

If you are reheating several plated meals one after the other, the reheating time can be reduced by around 5 minutes for the second and subsequent plates as the oven will still be hot.

Moisture content

The more moist the food, the less moisture that needs to be added.

Tips

- Food does not need to be covered before it is reheated.
- Do not reheat large items whole. Divide it into portions and reheat these as plated meals.
- Compact items, such as stuffed peppers or roulades, should be cut in half.
- Please note that breaded items will not retain their crispness when they are reheated.
- Reheat sauces separately, except for dishes such as stew and casseroles where the sauce is part of the dish.

Settings

Special Modes | Reheat
or

Operating Modes | Combi Steam | Convection Bake

Temperature: see chart

Moisture: see chart

Duration: see chart

Special modes

Food	🌡️ [°F / °C]	ΔΔ [%]	🕒 [min]
Vegetables			
Carrots Cauliflower Kohlrabi Beans	250 / 120	70	8–10
Side dishes			
Pasta Rice Potatoes, halved lengthways	250 / 120	70	8–10
Dumplings Mashed potato	285 / 140	70	18–20
Meat and poultry			
Sliced meat, 1/2" / 1 1/2 cm thick Roulades, sliced Beef stew Lamb ragout Chicken cutlets Turkey cutlets, sliced	285 / 140	70	11–13
Fish			
Fish fillet Fish roulade, halved	285 / 140	70	10–12
Plated meals			
Spaghetti, tomato sauce Roast pork, potatoes and vegetables Stuffed peppers (halved), rice Chicken fricassee, rice Vegetable soup Creamy soup Clear soup Stew	250 / 120	70	10–12

🌡️ Temperature / ΔΔ Moisture / 🕒 Duration

Defrost

Always follow USDA guidelines on food safety.

It is much quicker to defrost food in the steam oven than at room temperature.

Temperature

140°F / 60°C is the best temperature for defrosting.

Exception: 122°F / 50°C for minced meat and game

Before and after defrosting

Remove all packaging before defrosting.

Exceptions: Leave bread and baked goods in their packaging as otherwise they will absorb moisture and become soft.

Allow defrosted food to stand at room temperature after removing it from the oven. The standing time is necessary to allow the even distribution of heat.

Cooking pan

 Danger of salmonella poisoning. Do not use the liquid from defrosted meat or poultry. Dispose and wash the container, the sink and your hands.

Use a perforated container with a solid container underneath it when defrosting food which will drip, such as poultry. This way food will not be lying in defrosted liquid.

Foods which don't drip can be defrosted in a solid cooking pan.

Tips

- Fish does not need to be fully defrosted before cooking. Defrost so that the surface is sufficiently thawed to take herbs and seasoning. Depending on the thickness of the fish, 2–5 minutes should be enough.
- When defrosting food which has frozen together, e.g. berries, chops, fish filets etc. separate it about half-way through the defrosting time.
- Do not refreeze food once it has thawed.
- Defrost frozen ready meals according to the instructions on the packaging.

Settings

Special Modes | Defrost

or

Operating Modes | Steam Cooking

Temperature: see chart

Defrosting duration: see chart

Special modes

Food to be defrosted	Quantity	🌡️ [°F / °C]	🕒 [min]	⌚ [min]
Fruit				
Apple sauce	1/2 lb / 250 g	140 / 60	20–25	10–15
Apple chunks	1/2 lb / 250 g	140 / 60	20–25	10–15
Apricots	1 lb / 500 g	140 / 60	25–28	15–20
Strawberries	10.6 oz / 300 g	140 / 60	8–10	10–12
Raspberries / Black currants	10.6 oz / 300 g	140 / 60	8	10–12
Cherries	5.3 oz / 150 g	140 / 60	15	10–15
Peaches	1 lb / 500 g	140 / 60	25–28	15–20
Plums	1/2 lb / 250 g	140 / 60	20–25	10–15
Gooseberries	1/2 lb / 250 g	140 / 60	20–22	10–15
Vegetables				
Frozen in a block	10.6 oz / 300 g	140 / 60	20–25	10–15
Fish				
Fish filets	14 oz / 400 g	140 / 60	15	10–15
Trout	1 lb / 500 g	140 / 60	15–18	10–15
Lobster	300 g/10.6 oz.	140 / 60	25–30	10–15
Shrimp	10.6 oz / 300 g	140 / 60	4–6	5
Ready meals				
Meat, vegetables, side dishes / stew / soup	17 oz / 480 g	140 / 60	20–25	10–15
Meat				
Roast meat, sliced	4.4-5.3 oz. / 125–150 g each	140 / 60	8–10	15–20
Ground meat	1/2 lb / 250 g	125 / 50	15–20	10–15
Ground meat	1 lb / 500 g	125 / 50	20–30	10–15
Stew	1 lb / 500 g	140 / 60	30–40	10–15
Stew	2 lbs / 1000 g	140 / 60	50–60	10–15
Liver	1/2 lb / 250 g	140 / 60	20–25	10–15
Cutlets / chops / sausage	28 oz / 800 g	140 / 60	25–35	15–20
Poultry				

Special modes

Food to be defrosted	Quantity	🌡️ [°F / °C]	🕒 [min]	⌚ [min]
Chicken	2 lbs / 1000 g	140 / 60	40	15–20
Chicken thighs	5.3 oz / 150 g	140 / 60	20–25	10–15
Chicken filet	1 lb / 500 g	140 / 60	25–30	10–15
Turkey drumsticks	1 lb / 500 g	140 / 60	40–45	10–15
Baked goods				
Puff pastries / Yeast baked goods	–	140 / 60	10–12	10–15
Cakes and cookies	14 oz / 400 g	140 / 60	15	10–15
Bread / Rolls				
Rolls	–	140 / 60	30	2
Rye bread, sliced	1/2 lb / 250 g	140 / 60	40	15
Whole grain bread, sliced	1/2 lb / 250 g	140 / 60	65	15
White bread, sliced	5.3 oz / 150 g	140 / 60	30	20

🌡️ Temperature / 🕒 Duration / ⌚ Standing time

Special modes

Canning

Always follow USDA guidelines on food safety.

Only use unblemished, fresh produce which is in good condition.

Glass jars

Use clean glass jars and accessories and check them for any defects. Glass jars with twist off lids or glass lids with a rubber seal are suitable.

Make sure that all the glass jars are the same size so that bottling is carried out evenly.

After you have filled the jars with the bottled produce, clean the glass rims with a clean cloth and hot water and then seal the jars.

Fruit

Sort fruit carefully, rinse it briefly but thoroughly and allow it to drain. Take great care when cleaning soft fruit as it is very delicate.

Remove any peel, stalks, cores or pits. Cut up large fruit. For example, cut apples into slices.

If you are bottling fruit with pits (e.g. plums, apricots) without removing the pits, pierce the fruit several times with a fork or wooden skewer as otherwise it will burst.

Vegetables

Rinse, clean and cut up vegetables.

Vegetables should be blanched before bottling to help them retain their color (see "Blanching").

Fill volume

Fill the glass jars with produce up to a maximum of 1 1/4" (3 cm) below the rim. Do not pack down as this would damage the cell walls of the produce. Bang the jar gently on a cloth to help distribute the contents evenly.

Use a sugar solution for fruit and a salt or vinegar solution for vegetables.

Tips

- Make use of residual heat by leaving the jars in the oven for 30 minutes after it has switched off.
- Then cover the jars with a cloth and allow to cool for approx. 24 hours.

Method

- Place a perforated pan on the lowest shelf level.
- Place the jars (all the same size) in the perforated cooking pan. Ensure that they do not touch one another.

Settings

Special Modes | Canning

or

Operating Modes | Steam Cooking

Special modes

Juicing

This appliance is ideal for extracting juice from soft, firm and hard fruit.

It is best to use overripe fruit, as the riper the fruit the greater the quantity of juice produced. Very ripe fruit will also produce a more intense flavor.

Preparation

Sort and rinse the fruit. Cut out any blemishes.

Remove the stalks from grapes and cherries as these are bitter. The stalks do not need to be removed from berries.

Cut larger fruit into chunks approx. 1" (2 cm) in size. The harder the fruit the smaller the pieces should be.

Tips

- Try experimenting with mild and tart flavors.
- The juice quantity and aroma are improved if sugar is added to the fruit and is allowed to soak in for several hours. We recommend 1/4 - 1/2 cup (50-100 g) sugar per 2 lbs (1 kg) of sweet fruit and 1/2 - 3/4 cup (100-150 g) sugar for 2 lbs (1 kg) tangy fruit.
- If you wish to bottle the juice rather than consume it straight away, while still hot pour it into clean bottles and seal immediately.

Method

- Put the prepared fruit (cleaned, washed, chopped etc.) into a perforated cooking pan.
- Place a solid container or the universal tray underneath to catch the juice.

Settings

Operating Modes | Steam Cooking

Temperature: 210°F / 100°C

Duration: 40-70 minutes

Menu Cooking

You can cook up to three different types of food, e.g. fish with a side dish and vegetables.

The food can be selected in any order you like. The appliance will automatically sort them out in order of cooking duration required. The one with the longest duration goes in the oven first.

The Ready at and Start at functions are not available for "Menu Cooking."

Method

- Turn the steam oven on.
- Fill the water container and push it back in so that it engages.
- Then place the drip tray / universal tray (depending on model) in the appliance.
- Select Special Modes | Menu Cooking.
- Select the type of food.

Depending on the food, you will be asked about the size and the degree of doneness.

- Select or enter the values required and then confirm your selection with OK.
- Select Add next ingredient.
- Select the food you want and proceed in the same way as with the first ingredient.
- Repeat the procedure, if necessary, for the third ingredient.

After you have confirmed Start Menu Cooking, the display will tell you which food to put in the oven. At the end of

the preheating phase, the display will show when the next food type is to be placed in the oven. When the time for the next food type to be placed in the oven is reached, the display will show the food type and the shelf runner. This process will be repeated for the third food type.

You can still cook food types not listed on the display together. See "Menu Cooking - Manually" for details on how to do this.

Special modes

Dehydrate

Only use the special application Dehydrate or the Combi Steam | Convection Bake mode to dry food so that moisture can be dissipated.

Method

- Cut the food into similar sized pieces.
- Place the pieces on the rack covered with baking paper.

Tip: Bananas and pineapple are not suitable for drying in a combi steam oven.

Settings

Special Modes | Dehydrate

Temperature: see chart

Drying time: see chart

or

Operating Modes | Combi Steam | Convection Bake

Temperature: see chart

Drying time: see chart

Moisture: 0%

Food	🌡️ [°F / °C]	🕒 [h]
Apple, rings	160 / 70	6–8
Apricots, halved, pitted	140-160 / 60–70	10–12
Pears, sliced	160 / 70	7–9
Herbs	140 / 60	1.5–2.5
Mushrooms	160 / 70	3–5
Tomatoes, sliced	160 / 70	7–9
Citrus fruit, sliced	160 / 70	8–9
Plums, pitted	140-160 / 60–70	10–12

🌡️ Temperature / 🕒 Time (hours)

Making Yogurt

Always follow USDA guidelines on food safety.

To make yogurt, you will need either fresh live yogurt or yogurt culture, obtainable from health food stores.

Use natural yogurt with live culture and without additives. Do not use heat-treated yogurt.

The yogurt must be fresh (short storage time).

You can use either pasteurized or fresh whole milk. Pasteurized milk can be used without any further treatment. Fresh milk must first be heated to 195° F / 90° C (not boiled!) and then cooled down to 95° F / 35° C. Fresh milk will give a firmer yogurt than long-life milk.

The yogurt and milk should have the same percentage fat.

Do not move or shake the jars while the yogurt is thickening.

After preparing the yogurt, it must be immediately placed in the refrigerator to cool down.

The firmness, fat content and cultures used in the yogurt starter all affect the consistency of homemade yogurt. Not all yogurts are equally suitable as yogurt starters.

Possible causes for poor results

Yogurt is not set:

Incorrect storage of the yogurt starter, too much time out of the refrigerator, packaging was damaged, milk was insufficiently heated.

Liquid has not been removed:

Jars were moved, yogurt was not cooled down quickly enough.

Yogurt is grainy:

Milk was overheated or in poor condition, milk and starter yogurt not evenly stirred.

Tip: When using yogurt enzyme, yogurt can be made from a milk / cream mixture. Mix $\frac{3}{4}$ liter/3 cups milk with $\frac{1}{4}$ liter/1 cup cream.

Special modes

Method

- Mix ½ cup (100 g) yogurt with 4 cups (1 liter) of milk or make up the mixture with yogurt starter powder, following the instructions on the packaging.
- Pour the mixture into glass jars and seal them.
- Place the jars in a cooking pan. Ensure that they do not touch one another.
- Immediately after the yogurt has been made, place the jars in the refrigerator, taking care not to move them unnecessarily.

Settings

MasterChef | Special | Make Yogurt

or

Operating Modes | Steam Cooking

Temperature: 104°F / 40°C

Duration: 5:00 hours

Proofing

Method

- Prepare the dough according to the recipe.
- Place the bowl in a perforated cooking pan or on the rack.

Settings

Special Modes | Proof

Duration: as per recipe instructions

or

Operating Modes | Combi Steam | Convection Bake

Humidity: 100%

Temperature: 85°F / 30°C

Duration: as per recipe instructions

Dissolving Gelatine

Method

- **Gelatine sheets:** Completely cover the gelatine sheets with cold water and leave to soak for 5 minutes. Remove the gelatine sheets from the bowl and squeeze them out. Empty the bowl. Place the squeezed gelatine sheets back in the bowl.
- **Gelatine powder:** Place the gelatine powder in a bowl and add water according to the instructions on the packaging.
- Cover the bowl and place it in a perforated cooking pan.

Settings

MasterChef | Special | Dissolve Gelatine

or

Operating Modes | Steam Cooking

Temperature: 194°F / 90°C

Duration: 1 minute

Melting Chocolate

You can use the steam oven for melting any type of chocolate.

Method

- Break the chocolate into small pieces. Leave chocolate cake covering in its packaging, and place in a perforated cooking pan.
- Place large quantities in a solid container and small quantities in a cup or a bowl.
- Cover the container or the dish with a lid or with foil that is resistant to temperatures up to 212°F / 100°C and to hot steam.
- Stir large quantities once during cooking.

Settings

MasterChef | Special | Melt Chocolate

or

Operating Modes | Steam Cooking

Temperature: 149°F / 65°C

Duration: 20 minutes

Special modes

Skimming Fruits and Vegetables

Method

- Cut a cross in the top of tomatoes, nectarines etc. This will allow the peel to be removed more easily.
- Place the food in a perforated pan, if cooking with steam or a universal tray, if using the grill.
- For almonds, it is important to plunge them into cold water as soon as they are taken out of the oven otherwise the skin cannot be removed.

Settings

Operating Modes | Maxi Broil

Broil level: 3

Duration: see chart

Food	🕒 [min]
Bell Peppers	10
Tomatoes	7

🕒 duration

Operating Modes | Steam Cooking

Temperature: 210°F / 100°C

Duration: see chart

Food	🕒 [min]
Apricots	1
Almonds	1
Nectarines	1
Bell Peppers	4
Peaches	1
Tomatoes	1

🕒 Duration

Preserving Apples

You can treat homegrown apples in the steam oven to increase the length of time for which you can store them. Once treated, the apples will keep for 5 to 6 months when stored in a dry, cool and well-ventilated place. This method is only suitable for apples and not for other types of fruit.

Settings

MasterChef | Fruit | Apples | Whole | Preserving

or

Operating Modes | Steam Cooking
Temperature: 125°F / 50°C
Preserving time: 5 minutes

Blanching

Blanch fruit and vegetables before freezing them. Blanching helps maintain the quality of the produce when it is frozen.

Blanching vegetables also helps them retain their original color.

Method

- Put the prepared vegetables (cleaned, washed, chopped etc.) into a perforated cooking pan.
- Once blanched, plunge the vegetables into ice cold water to cool them down quickly. Drain them well.

Settings

Special Modes | Blanching

or

Operating Modes | Steam Cooking
Temperature: 210°F / 100°C
Blanching time: 1 minute

Special modes

Sweating Onions

Sweating means cooking the onions in their own juices, with the addition of a little fat if necessary.

Method

- Cut the onions up into small pieces and place them in a solid cooking pan with a little butter.
- Cover the container or the dish with a lid or with foil that is resistant to temperatures up to 212°F / 100°C and to hot steam.

Settings

MasterChef | Special | Steam Onions

or

Operating Modes | Steam Cooking
Temperature: 210°F / 100 °C
Duration: 4 minutes

Rendering Fat

The bacon will not become brown.

Method

- Place the bacon (diced or rashers) in a solid cooking pan.
- Cover the container with a lid or with foil that is temperature resistant up to 212°F / 100°C and to steam.

Settings

MasterChef | Special | Render Fat

or

Operating Modes | Steam Cooking
Temperature: 210°F / 100 °C
Duration: 4 minutes

Sanitizing Cookware

The steam oven will sanitize baby bottles and other cookware. Check beforehand that the manufacturer guarantees all components are to be heat resistant to 212° F / 100 °C and also steam resistant follow manufacturers instructions.

Dismantle, clean and thoroughly rinse baby bottles. Reassemble the bottles only after they have completely dried. This prevents recontamination.

Method

- Place the individual parts in a perforated cooking pan, ensuring that they do not touch one another (on their sides or with the opening facing downwards). This will allow the steam to reach the parts from all sides.
- Place the cooking pan on the lowest shelf level.

Settings

Special Modes | Sanitize Cookware
Duration: 1 minute to 10 hours

or

Operating Modes | Steam Cooking
Temperature: 210°F / 100°C
Duration: 15 minutes

Heating Damp Towels

Method

- Moisten the towels and then roll them up.
- Place them beside one another in a perforated cooking pan.

Settings

MasterChef | Special | Heat Damp Towels

or

Operating Modes | Steam Cooking
Temperature: 158°F / 70°C
Duration: 2 minutes

Special modes

Decrystallizing Honey

Method

- Loosen the lid and place the jar of honey in a perforated cooking pan.
- Stir the honey once during the cooking procedure.

Settings

MasterChef | Special | Decrystallize Honey

or

Operating Modes | Steam Cooking

Temperature: 140°F / 60°C

Duration: 90 minutes (irrespective of the size of jar or the amount of honey in the jar)

Pizza

Settings

Special Modes | Pizza

or

Operating Modes | Convection Bake

Temperature: 356-437°F / 180-225 °C

Duration: 1-20 minutes

Tip: Use the rack lined with baking parchment

Making jam

Only use unblemished, fresh produce which is in good condition.

Glass jars

Only use sterilised jars with twist-off lids up to a maximum capacity of 1 cup / 250 ml.

After pouring in the jam, clean the outside of the rim of the jar with a cloth and hot water.

Preparation

Sort fruit carefully, rinse it briefly but thoroughly and allow it to drain. Take great care when cleaning soft fruit as it is very delicate and squashes easily. Remove any stalks, cores or pits.

Purée the fruit as otherwise the preserve will not set. Add jam sugar to the fruit (according to packet instructions) and stir well.

For sweet fruit and berries you should also add some citric acid.

Method

- Fill jars maximum 2/3 full.
- Place the open jars in a perforated cooking pan or on the rack.
- At the end of the program take the jars out of the steam oven using oven gloves. Leave them to stand for 1 - 2 minutes before sealing them with twist off lids and then leave them to cool.

Settings

Operating Modes | Combi Steam | Convection Bake

Temperature: 302°F / 150°C

Moisture: 0%

Duration: 35 minutes

Special modes

Sabbath Program

This mode is designed for religious observance.

The program operates with Surround and cannot be changed.

The program will only start once the door is opened and closed:

- The steam oven will heat up to the temperature you have set and will maintain this temperature for a maximum of 72 hours.
- Sabbath Program appears in the display constantly.
- The time of day is turned off.
- The interior lighting does not come on, even when the door is opened.

If the Lighting | On setting has been selected, the lighting remains switched on when the Sabbath program has been selected and will stay on for the duration of the program.

The Sabbath program cannot be selected if the timer is being used.

Method

- Select Special Modes.
- Select Sabbath Program.
- Set the required temperature.
- Confirm with OK.

Sabbath Program and the set temperature will appear in the display.

The steam oven is ready for use.

- Open the door to start the program.
- Put the food in the oven.
- Close the door.

The program will start after approximately 5 minutes.

Once the "Sabbath" program has started it cannot be changed or saved as a Favorites.

To end the program early:

- Turn the steam oven off.

How it works

The metal tip of the roast probe is inserted into the food. There is a temperature sensor in the metal tip which measures the core temperature of the food during cooking.

The core temperature set will depend on how well cooked you want your meat to be and on the type of meat. The temperature can be set between 86 and 210°F / 30 and 99°C.

The cooking duration will depend on a number of different factors. The higher the temperature in the oven compartment and the humidity, where applicable and the thinner the meat, the quicker the set core temperature will be reached.

The cooking process will finish automatically when the core temperature in the meat reaches the value set for the roast probe. Exception: In Combi Steam mode or with user programs, another cooking stage, e.g., browning the meat, may be required.

Damage to roast probe by incorrect use!

If you are not using the roast probe remove it from the oven when cooking.

It is only protected from overheating when it is plugged in.

When to use the roast probe

The roast probe can be used in the following operating modes:

- Combi Steam | Convection Bake
- Combi Steam | Surround
- Convection Bake
- Convection Broil
- Surround
- Intensive
- Humidity Plus
- Steam Cooking
- Reheat

Roast probe

Important notes regarding the roast probe

Risk of breakage!

Do not use the roast probe to lift or carry the food.

The metal tip of the roast probe must be fully inserted into the center of the food.

Do not let the metal tip touch any bones, and do not insert it into a particularly fatty area of the meat.

If the meat is very heavily marbled with fat, select the highest core temperature given in the roasting chart.

When using roasting bags, insert the probe through the bag into the center of the meat.

You can also place the meat, with the roast probe inserted, inside the bag. Follow the roasting bag manufacturer's instructions.

If wrapping meat in aluminum foil, the roast probe must be inserted through the foil to the center of the meat.

Method

- Prepare the food.
- Insert the metal tip of the roast probe fully into the food.
- Place the food in the oven.

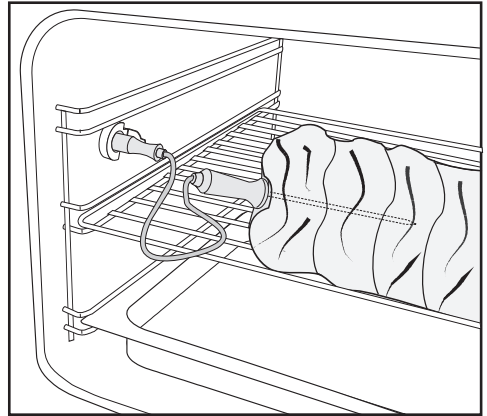

- Open the connection socket for the roast probe and insert the plug of the roast probe into the socket until you feel it engage.
- Select the desired mode.
- Alter the recommended and/or core temperature if necessary.

After the cooking process



Burn hazard!

The roast probe can get hot.

- Before taking the food out of the oven, carefully remove the roast probe plug from the connection socket.

Tips

- If you are cooking several pieces of meat together, the roast probe should be inserted into the largest piece of meat.
- If the food is not cooked sufficiently when the core temperature is reached, insert the roast probe into another place or increase the core temperature and repeat the program.

Roast

Always follow USDA guidelines on food safety.

Roasting tips

- Insert the grease filter in the back panel when roasting.

Frozen meat must be defrosted before it is cooked as it would dry out.

- Always defrost meat before roasting.
- Remove skin and sinew before roasting.
- Season the meat to taste and dot with butter, or in the case of game, bard with rashers of streaky bacon.

Tip: Game can be marinated overnight e.g. in buttermilk, to tenderize it.

- If you are cooking several pieces of meat together, select pieces that are similar in size.
- Roast meat on the rack above the universal tray. The cooking liquids will collect in the tray and can then be used to make a gravy or sauce.
- Allow a standing time of approx. 10 minutes after the end of cooking so that the cooking liquids are evenly distributed.

We recommend the Combi Steam | Convection Bake and Combi Steam | Surround modes for roasting.

If you wish to use other modes, you can enter your cooking stages as a user program (see "User programs").

Combi Steam

The lower the temperature in the oven compartment, the longer the cooking process and the more tender the result.

Lean meat

The addition of steam prevents the surface of lean meat from drying out. Excellent results can be achieved when using 5 cooking stages for the cooking process

- Cooking stage 1: the oven compartment and the rack above the universal tray are pre-heated.
- Cooking stage 2: the meat is browned.
- Cooking stage 3: adjust the temperature so that it is suitable for cooking the meat so that it is tender.
- Cooking stage 4: cook until tender.
- Cooking stage 5: continue cooking to the required level.

Fatty meat with crispy skin

- Cooking stage 1: use a high temperature to render the fat and brown the skin.
- Cooking stage 2: reduce the temperature and increase the moisture
- Cooking stage 3: increase the temperature for crispy skin.

Braised dishes

- Cooking stage 1: preheat the oven with the rack above the universal tray.
- Cooking stage 2: the meat is browned.
- Cooking stage 3: braise the meat at a temperature of 210°F / 100 °C with 84% moisture.

Poultry

- Cooking stage 1: use a high temperature and a high moisture level to render the fat.
- Cooking stage 2: lower the temperature.
- Cooking stage 3: increase the temperature and reduce humidity to dry out and crisp the skin.

For more information about relevant settings, please refer to the following roasting chart.





























Roast

Roasting chart































Always follow USDA guidelines on food safety.

The times and temperatures given in the tables are recommendations only.































Type of meat	Stage	Operating mode	🌡️ [°F / °C]	📊 [%]	⌚ [min]	🔌 [°F / °C]
Poultry						
Duck up to 4 lbs / 2 kg, stuffed	1		375/190	40	20	–
	2		210/100	80	140	–
	3		375/190	–	23	–
Duck up to 4 lbs / 2 kg, un-stuffed	1		375/190	40	20	–
	2		210/100	80	100	–
	3		375/190	–	23	–
Duck breast, medium	1		Level 3	0	15	–
	2		85/30	0	20	–
	3		Level 3	0	7–13	–
Duck breast, well-done	1		Level 3	0	15	–
	2		85/30	0	20	–
	3		Level 3	0	7–13	–
	4		85/30	0	5	–
Goose, approx. 9 lbs / 4.5 kg	1		375/190	40	30	–
	2		210/100	80	270	–
	3		375/190	–	23	–
Chicken, whole	1		435/225	0	20	–
	2		300/150	55	60	–
	3		Level 3	0	2–12	–
Chicken thighs	1		395/200	95	30–25	–
	2		440/225	0	13–18	–
	3		Level 3	0	0–7	–
Turkey roulade, stuffed/un-stuffed	1		375/190	40	20	–
	2		285/140	75	100	–
	3		395/200	–	4–8	–
Turkey breast	1		340/170	65	85	–
	2		Level 3	–	0–9	–

Type of meat	Stage	Operating mode	 [°F / °C]	 [%]	 [min]	 [°F / °C]
Veal						
Tenderloin (Roast)						
rare	–		347/175	–	–	115/45
medium	–		329/165	–	–	130/55
well done	–		320/160	–	–	165/75
Tenderloin (Roast with moisture)						
Rare*	1		Level 3	0	10	–
	2		Level 3	0	8	–
	3		140/60	0	30	–
	4		140/60	49	30	–
Medium*	1		Level 3	0	10	–
	2		Level 3	0	10	–
	3		210/100	0	20	–
	4		149/65	49	60	–
	5		158/70	51	60	–
Tenderloin (Roast with moisture)						
Well done*	1		Level 3	0	10	–
	2		Level 3	0	10	–
	3		210/100	0	20	–
	4		150/65	49	60	–
	5		195/90	68	50	–
	6		395/200	–	5	–
Saddle (Roast with moisture)						
Well done*	1		Level 3	0	10	–
	2		Level 3	0	10	–
	3		210/100	0	20	–
	4		150/65	49	60	–
	5		195/90	68	80	–
	6		395/200	–	5	–

Roast

Type of meat	Stage	Operating mode	 [°F / °C]	 [%]	 [min]	 [°F / °C]
Leg (Joint)	1		210/100	84	155	–
	2		375/190	–	17	–
Braised meat*	1		Level 3	0	10	–
	2		Level 3	0	10	–
	3		210/100	84	165	–
Lamb						
Leg of lamb	1		Level 3	–	18	–
	2		210/100	57	190	–
Loin / Crown Medium*	1		Level 3	–	10	–
	2		Level 3	–	8	–
	3		85/30	0	30	–
	4		165/75	47	40	–
Well done*	1		Level 3	–	10	–
	2		Level 3	–	10	–
	3		85/30	0	30	–
	4		210/100	57	100	–
Pork						
Tenderloin	–		395/200	–	–	167/75
Smoked pork	1		400/200	0	30	–
	2		266/130	100	–	167/75
Crispy pork	1		440/225	54	40	–
	2		210/100	84	120	–
	3		330-365/165-185	–	20-25	–
Pork loin	1		355/180	50	30	–
	2		265/130	30	–	167/75
Beef						
Tenderloin (Roast)						
rare	–		345/175	–	–	115/45
medium	–		338/170	–	–	130/55
well done	–		330/165	–	–	165/75

Roast

Type of meat	Stage	Operating mode	 [°F / °C]	 [%]	 [min]	 [°F / °C]
Tenderloin (Roast with moisture)						
Rare*	1		Level 3	0	10	–
	2		Level 3	0	10	–
	3		140/60	0	30	–
	4		140/60	49	30	–
Medium*	1		Level 3	0	10	–
	2		Level 3	0	10	–
	3		210/100	0	20	–
	4		149/65	49	60	–
	5		158/70	51	60	–
Tenderloin (Roast with moisture)						
Well done*	1		Level 3	0	10	–
	2		Level 3	0	10	–
	3		210/100	0	20	–
	4		150/65	49	60	–
	5		195/90	68	105	–
	6		395/200	–	8	–
Sirloin (Roast)						
rare	–		345/175	–	–	115/45
medium	–		338/170	–	–	130/55
well done	–		330/165	–	–	165/75
Tenderloin (Roast with moisture)						
Rare*	1		Level 3	0	10	–
	2		Level 3	0	10	–
	3		140/60	0	30	–
	4		140/60	49	30	–
Medium*	1		Level 3	0	10	–
	2		Level 3	0	10	–
	3		210/100	0	20	–
	4		149/65	49	60	–
	5		158/70	51	60	–

Roast

Type of meat	Stage	Operating mode	🌡️ [°F / °C]	💧 [%]	🕒 [min]	🔥 [°F / °C]
Well done*	1		Level 3	0	10	–
	2		Level 3	0	10	–
	3		210/100	0	20	–
	4		150/65	49	60	–
	5		195/90	68	135	–
	6		395/200	–	8	–
Roulades**	1		Level 3	0	10	–
	2		Level 3	0	10	–
	3		210/100	84	120	–
Pot roast**	1		Level 3	0	10	–
	2		Level 3	0	10	–
	3		210/100	84	205	–
Game						
Venison saddle						
Medium*	1		Level 3	–	10	–
	2		Level 3	–	7	–
	3		85/30	0	30	–
	4		165/75	52	40	–
Well done*	1		Level 3	–	10	–
	2		Level 3	–	13	–
	3		85/30	0	30	–
	4		210/100	47	107	–

🌡️ Temperature/Broil level / 💧 Moisture / 🕒 Duration / 🔥 Core temperature

Combi Steam Convection Bake / Combi Steam Maxi Broil / Combi Steam Surround / Maxi Broil / Convection Broil

* In stage one please place the universal tray on shelf level 1 and the rack on shelf level 2 (except with rack of lamb where the rack is placed **on** the universal tray on shelf level 1) without food on it and pre-heat the oven.

Place the meat on the pre-heated rack at the beginning of stage 2.

** * In stage one, place the universal tray on shelf level 2 without food on it and pre-heat the oven. Place the meat on the pre-heated tray at the beginning of stage 2.

Eating food which has been cooked correctly is important for good health.

Only bake cakes, pizza, french fries, etc. until they are golden brown. Do not overcook them.

Convection Bake

For baking on several levels at the same time. The fan distributes the heat evenly throughout the cavity for a consistent baking temperature.

- When using Surround, reduce the temperatures given for Convection Bake by about 20°F/20°C.

Surround

Heat is used from both the upper and lower heating elements to create perfect results of all baking recipes.

- Use only one shelf level for baking.
- Place tray bakes on the middle shelf.
- If using an older recipe or cookbook, set the oven temperature 10°F/10°C lower than that recommended. This will not change cooking durations.

Browning

For a perfectly browned topping, for example when making a gratin or browning the top of a casserole..

Bake

Use this at the end of the baking time to brown the bottom of the food.

Humidity Plus

For creamed mixtures, choux pastry and deep frozen pretzels.

Intensive Bake

For baking cakes with a moist topping, e.g. cheese cake, fresh fruit cakes, quiche and flans. Also suitable for items such as pizza without the need to pre-bake the base.

- Bake on the lowest shelf level.

Combi Steam

The gleaming finish on bread, rolls and puff pastry is achieved by adding steam (maximum moisture, low temperature) in cooking stage 1. Browning is achieved using a high moisture level and a high temperature. The drying-out phase takes place with low moisture and a high temperature.

Bake

Baking tips

Grease filter

- Remove the grease filter from the back wall. Otherwise results can be uneven.

Bakeware

- Dark-colored bakeware is best for baking. It conducts the heat more swiftly to the mixture. Shiny metal bakeware reflects heat so cakes take longer to cook and do not brown evenly.

Cakes baked in white tin bakeware require a longer baking duration.

- Bake cakes in rectangular bakeware with the longer side across the width of the oven compartment for optimum heat distribution and even results.

Universal tray

Because of its PerfectClean anti-stick surface, the universal tray does not need to be greased for baking.

Parchment paper

Parchment paper is only necessary when baking:

- Anything with a high salt content (e.g. pretzels, bread sticks), because sodium can damage the PerfectClean surface
- Meringues or dishes with a high egg white content, because they are more likely to stick
- Puff pastry

Frozen food

- When baking deep frozen products such as chips, croquettes, cakes, pizza and baguettes, use the lowest temperature quoted on the manufacturer's packaging.
- Cook frozen goods such as cakes, pizza or baguettes on a layer of baking parchment placed on the rack.

Baking large frozen items on the baking tray or the universal tray can cause the metal to distort to such an extent that the tray cannot be taken out of the oven.

- Small items of frozen food such as oven chips or potato croquettes can be cooked on the universal tray. Place them on baking parchment and turn several times during cooking.

Shelf level



















- When baking cakes with a moist topping only bake on one level.
- Use a maximum of two shelf levels at once. If you want to bake on two shelf levels at the same time, use the bottom and middle level.

Notes regarding the baking chart



























- As a general rule, select the lower temperature given in the chart.
- Do not set a temperature higher than that recommended. Increasing the temperature may reduce the baking duration, but will lead to uneven browning, and unsatisfactory cooking results.
- Check if the food is cooked at the end of the shortest duration quoted. To check if a cake is ready, insert a wooden skewer into the center. It is ready if the skewer comes out clean, without dough or crumbs sticking to it.

Bake

Baking chart

Baked good	Stage	Operating mode	🌡️ [F / °C]	ΔΔ [%]	🕒 min
Sponge					
Baking tray	–		300-355 / 150-180	–	25
Springform pan	–		320-340 / 160-170	–	25-35
Puff pastry					
Filled	1		210/100	100	7
	2		375-410/1	90	10
	3		90-210	75	5
	4		375-410/1 90-210 375-410/1 90-210	0	6
Small pastry*	–		355/180	–	15
Choux pastry					
Cream puffs / Éclairs	–		300-365/1 50-185	0	50
Yeast dough					
Bagels	1		210/100	100	10
	2		395/200	0	24
Baguettes, spelt bread	1		105/40	100	8
	2		125/50	100	4
	3		410/210	50	6
	4		355-410/1 80-210	0	30
Butter Cake	1		320/160	90	15
	2		250-330/1 20-165	0	10
Croissants	1		195/90	100	2
	2		320/160	90	10
	3		320-410/1 60-190	0	27

Bake

Baked good	Stage	Operating mode	🌡️ [F / °C]	ΔΔ [%]	🕒 min
Triple grain bread	1		85/30	100	15
	2		300/150	50	10
	3		300/150	0	100
Flat bread	1		105/40	100	10
	2		125/50	100	2
	3		410/210	0	6
	4		310-375/1 55-190	0	25
Braided loaf	1		105/40	100	8
	2		125/50	100	2
	3		395/200	50	10
	4		320-395/1 60-200	0	12
White bread in rectangular pan	1		105/40	100	8
	2		125/50	100	4
	3		410/210	50	6
	4		430/220	0	25-50
Herb rolls	1		310/155	90	9
	2		395/200	0	15-25
Multigrain rolls	1		310/155	90	9
	2		395/210	0	20-30
Pizza	-		350-400 / 175-205	-	35
Braided Swiss loaf	1		195/90	100	6
	2		340-410/1 70-210	50	45
Stollen	1		300/150	100	30
	2		265-320/1 30-160	0	30
Streusel Cake	1		85/30	100	30
	2		320/160	90	25
	3		265-355/1 30-180	0	10

Bake

Baked good	Stage	Operating mode	🌡️ [F / °C]	ΔΔ [%]	🕒 min
Sweet rolls	1		105/40	100	8
	2		125/50	100	2
	3		395/200	50	10
	4		395/200	0	8–13
Whole grain bread	1		105/40	100	8
	2		125/50	100	4
	3		410/210	50	6
	4		375-420/1 90-215	0	30
White bread	1		105/40	100	8
	2		125/50	100	4
	3		410/210	50	6
	4		340-410/1 70-210	0	30
White rolls	1		310/155	90	9
	2		395/200	0	20–30
Mixed wheat grain bread	1		105/40	100	8
	2		125/50	100	4
	3		410/210	50	6
	4		355-430/1 80-220	0	30
Onion tart	–		375/190	–	25–35
Short dough pastry					
Cookies	1		365/185	50	6
	2		365/185	0	10–15
Cakes with a dry topping	–		395/200	85	35
Cakes with a moist topping*	1		410/210	0	15
	2		375/190	0	20–30
Slice with topping	–		340-375/1 70-190	–	35–45
Quark dough					

Baked good	Stage	Operating mode	🌡️ [F / °C]	💧 [%]	🕒 min
Sweet rolls	1		125/50	100	5
	2		330/165	50	5
	3		330/165	0	14–26
Pizza	–		310-365/1 55–185	–	30
Baking tray	–		320-355/1 60–180	–	45–55
Batter					
Cake pan	–		340-375/1 70–190	–	55
Tray cake with fruit topping	–		340-375/1 70–190	–	40
Cookies	–		300-375 / 150–190	95	25
Pyramid cakes	–		Level 3	–	2–3**
Sourdough					
Rye mix bread	1		410/210	50	5
	2		375-410/1 90–210	0	50
Rye bread	1		410 / 210	60	6
	2		410 / 210	0	6
	3		310-340 / 155–170	0	60
Strudel					
Apple strudel	1		85/30	90	7
	2		375/190	0	35–60

🌡️ Temperature/Broil level / 💧 Moisture / 🕒 Duration

Combi Steam Convection Bake / Combi Steam Surround /

Surround / Convection Bake / Intensive Bake / Humidity Plus / Maxi Broil

* Pre-heat the oven with nothing in it.

** Per layer

Broil

 Burn hazard!

The appliance door must remain shut during broiling, as otherwise the controls will get hot.

The roast probe cannot be used with the Maxi Broil, Broil, and Combi Steam | Maxi Broil modes.

Maxi Broil

This function gives excellent browning and searing results. Use this function for chops, ribs, large quantities of meat and for browning large dishes.

Broil

This function is excellent for broiling or searing small quantities. Use this function for chops, ribs, small quantities of meat and for browning small dishes.

Convection Broil

For broiling thicker items, e.g. poultry or roulades.

Broiling tips

- Place the food on the rack on top of universal tray.
- When broiling fish, place the fish on a piece of baking paper cut to size.
- Place the food in the steam oven without pre-heating. Pre-heating the steam oven is not necessary when broiling.
- Broil thick items, e.g. half a chicken, in the middle and thin items, e.g. steak, on the top shelf level.
- Turn the food after $\frac{2}{3}$ of the cooking time has elapsed. Fish does not need to be turned.

Tips

- Marinate or add a little oil if necessary to lean meat. Do not use other types of fat as they can burn and cause smoke.
- Make diagonal cuts in sausage before broiling.
- It is best to broil food of a similar thickness at the same time so that the broiling time for each item does not vary too greatly.
- To broil thicker pieces of food more gradually after an initial high temperature, continue broiling at a lower temperature setting or use a lower shelf runner to allow the food to cook through to the center.

Broil

Broiling table

Broiled food	Operating mode	🌡️ [F / °C]	💧 [%]	🕒 min
Fish				
Trout		Level 3	–	25–30
Salmon		355/180	–	35
Mackerel		Level 3	–	25
Meat / sausages				
Hamburgers		Level 3	–	20
Sausage fresh / pre-cooked		Level 3	–	15–20
Miscellaneous				
Toast		Level 3	–	5–8
Toast with toppings		Level 3	–	8–15
Corn on the cob		Level 3	30	23

🌡️ Temperature/Broil level / 💧 Moisture / 🕒 Duration

Maxi Broil / Convection Broil / Combi Steam Maxi Broil

Accessing the "Settings" menu

- Select Settings .

A list of settings will appear in the display.

They can be checked and changed, if needed.

A check  next to an option shows which setting is active.







Settings cannot be altered while a cooking program is in progress.

Changing and saving settings

- Select Settings .
- Scroll through the list until the desired setting appears.
- Touch the sensor next to the setting. The desired setting may appear in a sub menu.
- Change the setting.
- Confirm with OK.
- Tap "Back" until the main menu appears or select another setting.

Settings

Settings overview

Option	Available settings
Language 	... / deutsch / english / ... Country
Time	Show On / Off * / Night Dimming Clock Format 24 h / 12 h * Set
Date	
Lighting	On / On for 15 Seconds *
Display Brightness	
Audible tone information	Melody  Solo Tone 
Keypad Tone	
Units of Measurement	Weight g * / lb / lb:oz Temperature °C * / °F
Keeping Warm	On / Off *
Automatic Rinsing	On * / Off
Steam Reduction	On * / Off
Default Temperature	
Safety	System Lock  On / Off * Sensor Lock On / Off *
Water Hardness	Soft Medium Hard *
Showroom Program	Demo Mode On / Off *
Factory Default	Settings Favorites Default Temperature

* Factory default

Language

The desired country and language can be set.

After selecting and confirming your choice, the language selected will appear in the display.



Tip: If you accidentally select a language you do not understand, select the  symbol to return to the submenu.

Time of day



Display

Select how you would like the time of day to show on the display when the steam oven is turned off:

- On

The time of day always appears in the display. You can switch the lighting  on and off, use the timer  or open the control panel  by tapping the relevant sensor button.

- Off

The display is switched off to save energy. The steam oven has to be switched on before you can use it. This also applies to using the oven interior lighting  and the timer  functions and opening the control panel .

- Night Dimming

To save energy, the time is only visible on the display between 5:00 am and 11:00 pm. The rest of the time it is not visible.

Clock format

You can select the clock format for the time of day:

- 24 h

The time of day is shown in 24 hour clock format.

- 12 h

The time of day is shown in 12 hour clock format.

Setting the time

Set the hours and the minutes.

If there is an interruption to the power supply, the current time of day will reappear once power has been re-stored. The time is stored in memory for about 200 hours.

Date

Set the date.

When the steam oven is turned off, the date will only appear on the display if the Time | Show | On is selected.

Settings

Lighting

- On

The interior lighting is turned on during the entire cooking period.

- On for 15 Seconds

The oven lighting turns off 15 seconds after a program starts. Touching  turns it on for another 15 seconds.

Display brightness

The display brightness is represented by a bar with seven segments.



- Select **Darker** or **Brighter** to change the brightness of the display.

Acoustic tone information

Melody

At the end of a process, a melody will sound several times in intervals.

The volume of the melody is represented by a bar with seven segments.



Maximum volume is selected when all segments are filled. If none of the segments are filled, the melody is turned off.

- Select **Quieter** or **Louder**, to adjust the volume.
- Select **On** or **Off**, to turn the melody on or off.

Solo tone

At the end of a process, a continuous tone will sound for period of time.

The pitch of this tone is represented by a segment bar.

- Select **Lower** or **Higher**, to change the pitch.

Keypad tone

An audible tone is heard with each touch of a sensor.

The volume of the keypad tone is represented by a bar with seven segments.



Maximum volume is selected when all segments are filled. If none of the segments are filled, the volume is turned off.

- Select **Quieter** or **Louder**, to adjust the volume.
- Select **On** or **Off**, to turn the keypad tone on or off.

Units of measurement

Weight

– g

The weight of food in MasterChef programs is shown in grams.

– lb

The weight of food in MasterChef programs is shown in pounds.

– lb:oz

The weight of food in MasterChef programs is shown in pounds and ounces.

Temperature

– °C

The temperature is displayed in Celsius.

– °F

The temperature is displayed in Fahrenheit.

Settings

Keeping Warm

Please note that delicate food, especially fish, can continue cooking while being kept warm.

– On

The "Keeping Warm" function is activated as standard with the Steam Cooking mode if a minimum temperature of about 175°F / 80°C is used for cooking. If food is not removed from the steam oven at the end of a program, this function will automatically start after approx. 5 minutes. Keeping Warm will appear in the display and the food will be kept warm for approx. 15 minutes at a temperature of 160°F / 70°C. The warming function is canceled when the illuminated sensor button is tapped or "Back" when the door is opened.

– Off

The "Keeping Warm" function is deactivated.

Automatic rinsing

Following a cooking program with steam, Appliance Rinsing will appear in the display after the steam oven has been switched off.

Any remaining food deposits are flushed out of the system.

You can activate or deactivate the automatic rinsing process.

Steam reduction

– On

If you cook at a temperature from approx. 175°F / 80°C (Steam Cooking) or 175-210°F / 80-100°C and a 100% humidity setting (Combi Steam), the steam reduction function switches on automatically at the end of the cooking program. This reduces the amount of steam which escapes from the appliance when the door is opened at the end of the cooking duration. Steam Reduction will appear in the display in addition to Program Finished.

– Off

If steam reduction is turned off the Keeping Warm function is also automatically turned off. If steam reduction is turned off a large amount of steam will escape when the door is opened.

Default temperatures

If you often cook with temperatures that differ from the default, it makes sense to change the default temperatures.

After selecting this option, a list of oven modes will appear in the display.

- Select the desired mode.

The default temperature is displayed along with the available temperature range.

- Change the default temperature.
- Confirm with OK.

Safety

System lock

The system lock prevents the appliance being turned on by mistake.

The timer can still be used when the system lock is active.

The system lock will remain activated even after a power failure.

- On

The system lock is now active. If you want to use the steam oven after activation, press and hold the sensor button next to OK for at least 6 seconds.

- Off

The system lock is not active. You can use the steam oven as normal.

Settings

Sensor lock

The sensor button lock prevents you from accidentally turning the oven off or changing a cooking program.

– On

The sensor lock is active. Press and hold OK for at least 6 seconds to use the sensors again. The sensor lock is then deactivated for a short period of time.

– Off

The sensor lock is not active. All sensors react to touch as normal.

Water hardness

The steam oven is factory set for Hard water. It must be adjusted to local water hardness to ensure trouble-free operation and to ensure that descaling is carried out at the correct interval. The harder the water, the more often it will need to be descaled.

– Soft

< 8.7 °gr/gal, < 1.5 mmol/l

– Medium

8.7 - 14.6 °gr/gal, 1.5 - 2.5 mmol/l

– Hard

> 14.6 °gr/gal, > 2.5 mmol/l

Showroom Program

This mode enables the oven to be demonstrated in showrooms without heating up. It should not be set for domestic use.

Demo Mode

If demo mode is activated Demo mode active. The appliance will not heat up **will** appear when the steam oven is turned on.

– On

Press and hold OK for at least 4 seconds to activate demo mode.

– Off

Press and hold OK for at least 4 seconds to deactivate demo mode. The steam oven can then be used as normal.

Factory default

– Settings

Any settings that have been altered will be reset to the factory default setting.

– Favorites

All Favorites will be deleted.

– Default Temperature

Any default temperatures that have been changed will reset to the factory default settings.

Cleaning and care

Important information on cleaning and care



Risk of injury!

The steam from a steam cleaner could reach electrical components and cause a short circuit.

Do not use a steam cleaner to clean the steam oven.

All surfaces can become discolored or damaged if unsuitable cleaning agents are used. The front of the oven, in particular, will be damaged by oven cleaners.

All surfaces are susceptible to scratching. Scratches on glass surfaces may cause a breakage.

Immediately remove any residues left by cleaning agents.

Stubborn soiling could damage the steam oven in certain circumstances.

Once the oven has cooled clean the oven, the inside of the door and the door seal. Waiting too long to clean the oven will make it much more difficult to clean.

Do not use commercial cleaning agents. Only use agents designed for domestic use.

Do not use cleaning agents or liquid dish soap containing aliphatic hydrocarbons as these could cause the seals to swell.

Allow the appliance to cool down to a safe temperature before cleaning.

- The appliance and accessories should be cleaned and dried thoroughly after each use.
- Leave the appliance door open until the oven interior is completely dry.

If the appliance is not going to be used for a longer period of time, e.g. while on vacation, it should be thoroughly cleaned and dried beforehand to prevent the build-up of odors, etc. Leave the door open afterwards.

To better maintain your appliance avoid the following:

To avoid damaging surfaces when cleaning, do not use:

- Cleaners containing soda, ammonia, thinners, or chlorides
- Descaling agents
- Abrasive cleaning agents (e.g., powder or cream cleansers, pumice stones)
- Solvent-based cleaners
- Stainless steel cleaners
- Dishwasher cleaners
- Ceramic cooktop cleaners
- Hard, abrasive brushes or sponges (e.g. pot scrubbers or scrub sponges, sponges which have previously been used with abrasive cleaning agents)
- Eraser sponges
- Sharp metal scrapers
- Steel wool
- Stainless steel spiral pads
- Spot cleaners
- Oven sprays

Glass cleaners **may be used** to clean the exterior. However **do not** allow them to sit or "puddle", this can cause damage to the surface. **Remove the cleaner promptly.**

Appliance front

- Clean the front with a solution of warm water and liquid dish soap applied with a clean sponge or cloth. A clean, damp microfiber cloth without cleaning agent can also be used.
- After cleaning dry the front of the appliance with a soft cloth.

Cleaning and care

PerfectClean

The surfaces of the oven compartment and shelf runners have been treated with **PerfectClean** enamel. This finish has an iridescent appearance. PerfectClean surfaces have very good non-stick properties and are easy to clean.

However, it is very important to clean the surfaces each time the oven is used.

The surface will become harder to clean and the non-stick properties will deteriorate if soiling is not removed after each use and allowed to build up.

Soiling such as spilt juices and cake mixtures are best removed while the oven or tray is still warm. Exercise caution, make sure the oven is not hot.

Spilt fruit juices may cause lasting discoloration of the surfaces. This discoloration is permanent but will not affect the efficiency of the surface.

Remove residual cleaning agent after cleaning. If left it will reduce the non-stick properties of the PerfectClean surfaces.

To protect the non-stick effect of PerfectClean surfaces, please avoid:

- Abrasive cleaning agents, such as scouring powder, scouring cream, pumice pits
- Ceramic cooktop cleaners
- Ceramic and stainless steel cleaner
- Steel wool
- Abrasive sponges, e.g. pot scourers or sponges which have been previously used with abrasive cleaning agents
- Oven sprays
- Cleaning in the dishwasher
- Spot cleaners

Do not use oven spray.

Oven interior

The surface of the oven compartment has been treated with PerfectClean.

Please refer to the section on "PerfectClean" for information on cleaning and care.

The oven door (see "Door") and the side runners (see "Side runners") can be removed to make it easier to clean the oven interior.

After a program using steam

- Remove:
 - Condensate using a sponge or absorbent cloth
 - Light, greasy soiling with a sponge and a solution of liquid dish soap and hot water
- After cleaning, wipe with clean water to remove any detergent residues.
- Then dry the oven interior and the inside of the door with a cloth.

Tip: You can then leave the oven to dry automatically (see "Cleaning and care - Drying").

After a roasting, broiling or baking program

Clean the oven compartment thoroughly after roasting and baking as otherwise soiling can burn on and become impossible to remove.

- Remove light soiling from the oven compartment and the inside of the door using a soft clean sponge and a mild solution of warm water and liquid dish soap. If necessary, the pad on the reverse of the sponge can be used to clean the oven compartment.
- After cleaning, wipe with clean water to remove any detergent residues.
- Then dry the oven interior and the inside of the door with a cloth.

Tip: Soaking the soiling for a few minutes with a solution of washing-up liquid and hot water can make cleaning easier. Alternatively run the Maintenance | Soak program (see "Maintenance - Soak").

Cleaning and care

Drain filter

- The filter in the floor of the oven should be cleaned and dried after every use.
- Vinegar can be used to remove discoloration and limescale deposits from the filter in the floor of the oven. Rinse thoroughly with clean water to remove any residual cleaning agent.

Door gasket

Grease deposits on the seal between the inside of the oven door and the oven interior can cause it to become brittle and cracked.

- Clean the door seal after every baking or roasting program using a clean, damp microfiber cloth or a soft clean sponge and a mild solution of warm water and liquid dish soap.
- After cleaning, dry the seal with a soft cloth.
- Replace the seal with a new one if it becomes porous or brittle.

Door seals can be ordered from the Miele Service (see the end of this booklet for contact details).

Grease filter

Clean the grease filter after every roasting program.

The grease filter can be cleaned in a dishwasher.

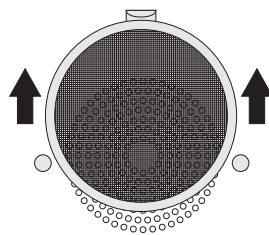

- Pull the grease filter on the back panel upwards to remove it.
- The grease filter can be cleaned in the dishwasher or by hand with a soft clean sponge and a mild solution of warm water and liquid dish soap.

If the grease filter is cleaned in the dishwasher, results are better if the filter is placed horizontally in the basket. Some dishwasher detergents may cause the surface of the filter to discolor. This discoloration will not affect the functioning of the filter in any way.

Water container and condensate container

The water container and condensate container are suitable for cleaning in a dishwasher.

- Remove and empty the water container and condensate container after every use. Push upwards slightly as you take them out of the appliance.

Water can drip into the water container and condensate container compartment when removing the containers.

- Dry the compartment with a soft cloth.
- Rinse the water container / condensate container by hand or in the dishwasher.
- Then dry the water container and condensate container with a soft cloth to prevent limescale.

Accessories

Cooking pans

The cooking pans are suitable for cleaning in the dishwasher.

- Wash and dry the cooking pans after each use.
- Vinegar can be used to remove bluish discoloration. Rinse thoroughly with clean water to remove any residual cleaning agent.

Universal tray and wire oven rack

The surface of the universal tray and the wire oven rack have been treated with a PerfectClean finish.

Do not clean the universal tray and wire oven rack in the dishwasher.

Please refer to the section on "PerfectClean" for information on cleaning and care.

- Remove:
 - light soiling with a soft clean sponge and a mild solution of warm water and liquid dish soap.
 - heavier soiling with a clean non-scouring sponge and a soft clean sponge and a mild solution of warm water and liquid dish soap. If necessary, the pad on the reverse of the sponge can be used.
- After cleaning, wipe with clean water to remove any detergent residues.
- Dry the surface of the universal tray and the wire oven rack with a soft cloth.

Cleaning and care

Roast probe

Do not immerse the roast probe in water or clean it in the dishwasher as this will damage it.

- Clean the roast probe with a damp cloth after every use.

Shelf runners

The surface of the side runners has been treated with PerfectClean. Do not clean the side runners in the dishwasher.

Please refer to the section on "PerfectClean" for information on cleaning and care.

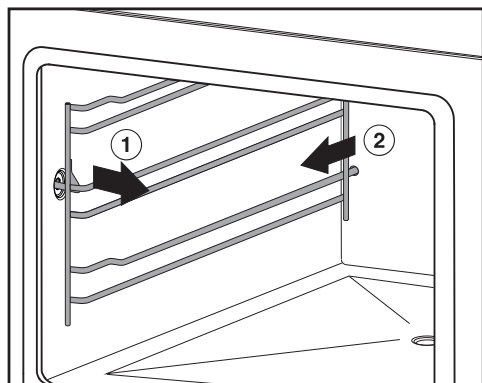

- Pull the side runners out first at the side ①, then at the back ② of the steam oven.

- Remove:

- light soiling with a clean sponge and a solution of washing-up liquid and hot water.
- heavier soiling with a clean non-scouring sponge and a soft clean sponge and a mild solution of warm water and liquid dish soap. If necessary, the pad on the reverse of the sponge can be used.

- After cleaning, wipe with clean water to remove any detergent residues.
- Dry the side runners with a soft cloth.
- Push the side runners firmly back in after cleaning. When putting them back in, make sure they are correctly inserted (see illustration).

If the side runners are not correctly inserted there is no anti-tip protection, items could be pulled out of the steam oven inadvertently and the temperature sensor could be damaged when cooking pans are placed in the steam oven.

Maintenance

The Ready at and Start at functions are not available in Maintenance.

Soak

Heavy soiling can be soaked with this program after a roasting program.

- Allow the oven cavity to cool down.
- Remove all accessories from the oven.
- Fill the water container.
- Select Maintenance | Soak.

The soaking process takes approx. 10 minutes.

Drying

Residual moisture in the oven compartment is dried, even in inaccessible areas.

- Dry the oven cavity with a soft cloth first.
- Select Maintenance | Drying.

The drying process takes approx. 20 minutes.

Rinsing

During this process the water-bearing system is rinsed. Any possible food residues are rinsed out.

- Select Maintenance | Rinses.
 - Follow the instructions on the display
- Rinsing takes approx. 10 minutes.

Descaling

We recommend that you use Miele Descaling Tablets (see "Optional accessories") for descaling the appliance. They have been specifically designed for optimal descaling of Miele products. Other descaling agents, which - in addition to citric acid - may contain other acids and/or other undesirable substances such as chlorides, might damage the product. Also, the desired effect cannot be guaranteed if the descaling solution does not have the required concentration.

Descaling solution is acidic.

Do not spill descaling agent onto metal surfaces. This can cause marks to appear.

However, should any descaling agent get onto these surfaces, wipe it away immediately.

The steam oven needs to be descaled after a certain number of operating hours. When the steam oven needs to be descaled, a number will appear in the display indicating the number of cooking processes remaining before the appliance locks out. Only cooking processes using steam are counted. After the last remaining steam cooking process, the appliance will lock out.

We recommend that you descale the appliance before it locks out.

During the descaling process, the water container must be rinsed out and re-filled with fresh water and the condensate container must be emptied.

- Turn the steam oven off and select Maintenance | Descale.

Cleaning and care

The message *Please wait...* will appear in the display. The descaling process is being primed and may take a few minutes. As soon as the appliance is ready you will be prompted to fill the water container.

- Fill the water container with cold water to the marking  and add 2 Miele descaling tablets.
- Push the water container into the appliance until it engages.
- Confirm with OK.
- Empty the condensate container.
- Confirm with OK.

The descaling process will now begin, and the time left will count down on the display.

It is only possible to cancel the descaling process during the first 6 minutes. Do not turn the appliance off during the descaling process. If it is turned off before the end of the process, the whole process will have to be started from the beginning again.

The water container will need emptying and rinsing twice and refilling with fresh tap water during descaling. The condensate container must be emptied.

- Follow the instructions on the display.
- Confirm with OK.

Once this has taken place Empty the Condensate Container will appear in the display.

- Follow the instructions in the display.
- Confirm with OK.

The descaling process is complete.

After descaling

- Remove, empty, and dry the water container and condensate container.
- Turn the steam oven off.
- Dry the oven compartment.
- Leave the appliance door open until the oven interior is completely dry.

Door

Removal

- Prepare a suitable underlay for the door, such as a soft cloth.

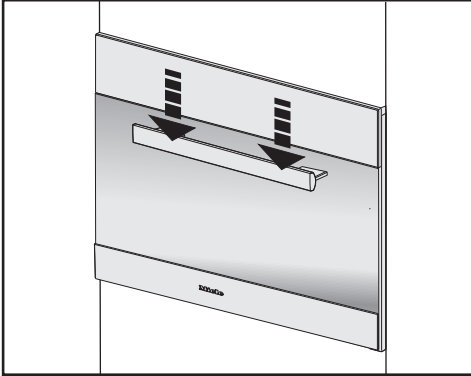

- Push the door downwards by the handle.

Before removing the door, the locking clamps on both hinges have to be released.

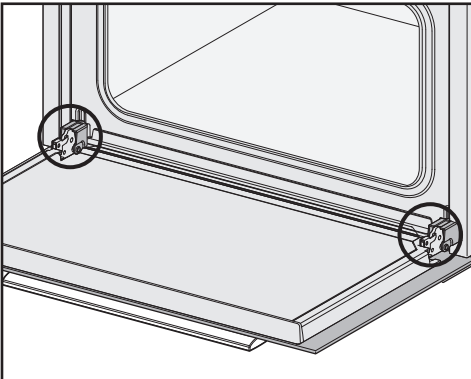

- Open the door fully.

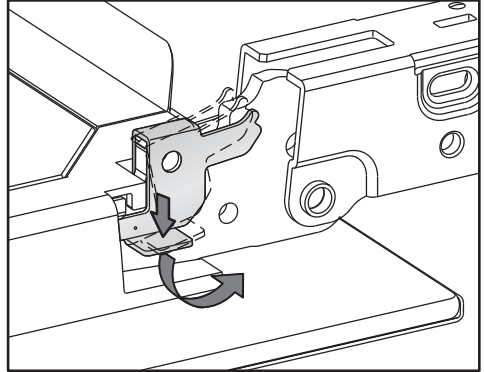

- Release the locking clamps on the hinges by pushing them down. Turn them as far as they will go in an angled position.

⚠ Danger of injury due to the hinge guides!

The hinge guides retract to the steam oven.

Never attempt to pull the door off the hinge guides from a horizontal position.

- Close the door until it rests partially open.

Risk of damage to the door!

The door handle could break off and the glass could be damaged.

The door should be gripped firmly at the sides and not at the handle when being removed.

Make sure that the door is not tilted during removal.

Cleaning and care

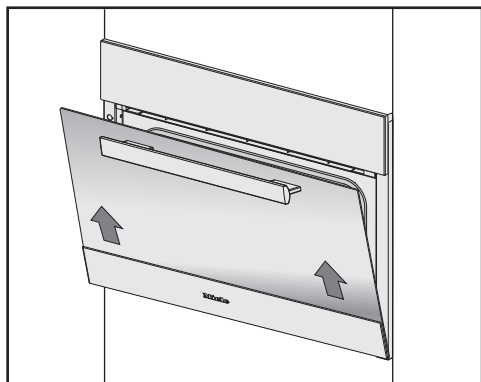

- Hold the door on either side and pull diagonally upwards from the hinge guides.
- Lay the appliance on the previously prepared underlay.

Refitting the door

Risk of damage to the door!
Make sure that the door does not cant when being refitted.

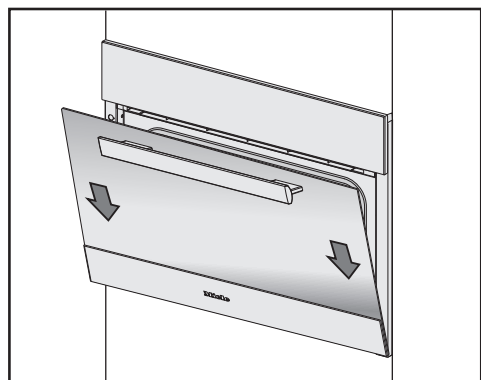

- Slide the door onto the hinge guides again.

Risk of damage to the door!
If the locking clamps are not locked, the door can easily become detached from the hinge guides and be damaged.
You must make sure that the locking clamps are locked again.

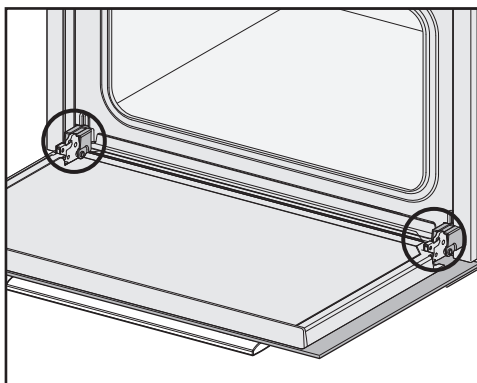

- Open the door fully.

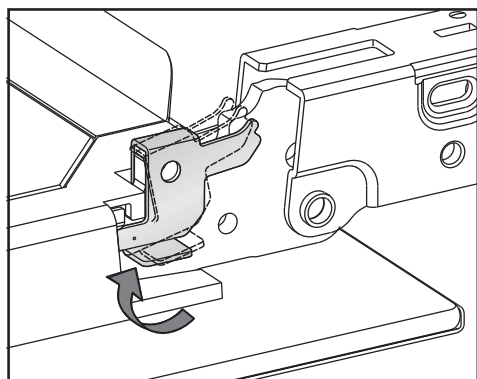

- To relock the locking clamps, turn them back up to the horizontal position as far as they will go.

Frequently asked questions

The following faults can be corrected without contacting the Miele Service Department.

If in doubt, please contact Miele.

 **Risk of injury!** Improperly performed installation, maintenance or repair work can pose a serious danger to users of the appliance. Installation, maintenance and repairs may only be carried out by Miele authorized technicians.
Do not attempt to open the housing.

Problem	Possible cause and solution
You cannot turn the appliance on.	<p>The circuit breaker has tripped.</p> <ul style="list-style-type: none"> ■ Reset the circuit breaker (see data plate for the correct fuse rating). <p>There may be a technical fault.</p> <ul style="list-style-type: none"> ■ Disconnect the appliance from the power supply for approx. 1 minute: <ul style="list-style-type: none"> – tripping the relevant circuit breaker or screwing the fuse out completely, or – tripping the ground fault circuit interrupter (GFCI). ■ If the steam oven still will not turn on, contact a qualified electrician or Miele Service.
The steam oven does not heat up.	<p>Demonstration mode is active</p> <ul style="list-style-type: none"> ■ Deactivate Demo mode (see "Settings – Showroom Program").
The fan can still be heard after the appliance has been turned off.	<p>The fan is still running. The appliance is fitted with a fan which removes steam from the oven. The fan will continue to run for a while after the appliance has been switched off. It will turn itself off automatically after a while.</p>
A humming sound can be heard after switching on the appliance, during operation and after turning off the appliance.	<p>This is not a fault. It is made by water being pumped through the system.</p>

Frequently asked questions

Problem	Possible cause and solution
<p>After moving house the appliance no longer turns from the heating-up phase to the cooking phase.</p>	<p>The boiling temperature of the water has changed as the altitude of the new location for the appliance differs from the old one by at least 984' / 300 m.</p> <ul style="list-style-type: none"> ■ To adjust the boiling temperature, you need to descale the appliance (see "Cleaning and care - Descaling").
<p>During operation, an unusually large amount of steam escapes or steam escapes from parts of the steam oven where it does not usually.</p>	<p>The door is not properly closed.</p> <ul style="list-style-type: none"> ■ Close the door.
	<p>The door seal is not correctly fitted.</p> <ul style="list-style-type: none"> ■ If necessary, press it in all the way round the door to make sure it is fitted evenly.
	<p>The door seal is damaged, e.g. cracked.</p> <ul style="list-style-type: none"> ■ Replace the door seal. This can be ordered from Miele Service (see the end of this booklet for contact details).
<p>The control panel will not open or close automatically despite tapping the  sensor button several times.</p>	<p>There is an obstruction in the control panel.</p> <ul style="list-style-type: none"> ■ Remove the obstruction.
	<p>The obstruction sensor is very sensitive, which means the control panel sometimes does not open or close.</p> <ul style="list-style-type: none"> ■ Open/close the control panel manually (see end of this section) ■ If the problem occurs again, contact Miele Service.
<p>The oven lighting does not come on.</p>	<p>The lamp needs to be replaced.</p> <ul style="list-style-type: none"> ■ Contact Miele Service to have the lamp replaced.
<p>The <small>Start at</small> and <small>Ready at</small> functions have not worked.</p>	<p>The oven cavity temperature is too high, e.g. after a program has finished.</p> <ul style="list-style-type: none"> ■ Leave the door open to cool down the oven cavity.
	<p>These functions are not generally available with Menu Cooking and Maintenance.</p>

Frequently asked questions

Problem	Possible cause and solution
Cakes and pastry are not cooked properly after following the durations given in the recipe.	The set temperature is not consistent with the one given in the recipe. ■ Change the temperature.
	The grease filter is inserted in the back panel. Baking takes longer with this filter in place. ■ Increase the baking duration.
	The recipe has been altered. For example, adding more liquid or eggs can increase the duration required. ■ Adapt the temperature or baking duration accordingly.
Cakes or pastry are unevenly browned.	The temperature was set too high.
	The grease filter has not been taken out of the back wall.
	More than two shelf levels were used for baking. ■ Bake on a maximum of two levels.
F10	The suction hose in the water container is – is not inserted correctly. – is not positioned vertically. ■ Connect it properly and make sure it is vertical: <div data-bbox="631 916 815 1070" data-label="Image"> <p>The diagram shows a cross-section of a water container with a suction hose. The hose is inserted into a vertical slot and is held in place by a clip. An arrow points downwards from the top of the slot, indicating the direction of water flow. The hose is shown in a vertical orientation, demonstrating the correct installation method.</p> </div>
F11 F20	The drain hoses are blocked. ■ Descale the steam oven (see "Cleaning and care - Descaling"). ■ If the fault message appears again, switch the appliance off and contact Miele Service.
F44	Communication fault ■ Turn the steam oven off and then back on again after a few minutes. ■ If the same message appears again, contact Miele Service.

Frequently asked questions

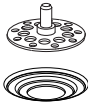
Problem	Possible cause and solution
F 55	<p>The maximum length of time for which the combi steam oven can be operated on a function has been exceeded, so the appliance has switched itself off automatically for safety reasons.</p> <ul style="list-style-type: none">■ Switch the steam oven off and then back on again. <p>The steam oven is immediately ready for use again.</p>
F 196	<p>There is a fault.</p> <ul style="list-style-type: none">■ Switch the steam oven off and then back on again. <p>The drain filter is not inserted correctly.</p> <ul style="list-style-type: none">■ Turn the steam oven off.■ Insert the filter correctly: <div data-bbox="680 619 768 721" data-label="Image">A technical diagram showing a circular drain filter with a central protrusion being inserted into a matching circular drain pan. The filter is shown in two positions: one above the pan and one partially inserted into it.</div> <ul style="list-style-type: none">■ Switch the steam oven back on again.■ If, having corrected the problem, this fault message appears again, contact Miele Service.
F and other fault codes	<p>Technical fault</p> <ul style="list-style-type: none">■ Turn the appliance off and contact Miele.

Opening the control panel manually

- Open the appliance door carefully.

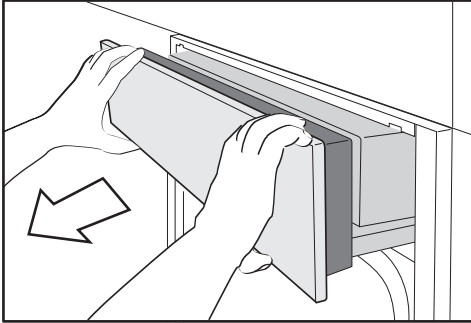

- Hold the control panel at the top and bottom.
- Pull out the panel towards you.
- Carefully push it upwards.

Closing the control panel manually

- Hold the control panel at the top and bottom.

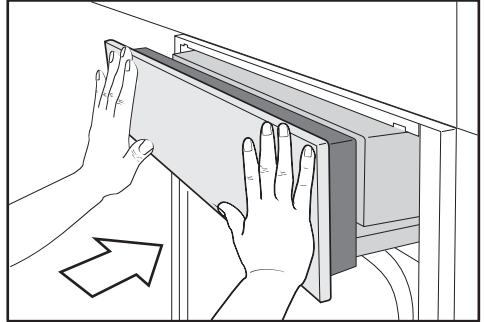

- Carefully push it downwards.
- Push the panel right in.

Optional accessories

Miele offers a range of useful accessories, as well as cleaning and conditioning products for your appliance.

Depending on country, these can be ordered online from Miele.

You can also obtain these products from Miele Service (see end of this booklet for contact details) or your Miele dealer.

Cooking pan

There is a wide range of perforated and solid cooking pans available in different sizes:

Miele offers a number of perforated and solid cooking pans in various sizes. Cooking pans with a width of **12 3/4" (325 mm)** cannot be inserted directly into the shelf runners. Instead they must be placed on the rack.

DGGL 1

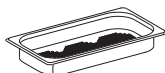

Perforated cooking pan
12 3/4" x 7" x 1 1/2" (WxDxH)
325 x 175 x 40 mm (WxDxH)

DGG 2

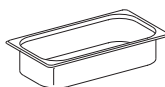

Solid cooking pan
12 3/4" x 7" x 2 1/2" (WxDxH)
325 x 175 x 65 mm (WxDxH)

DGG 3

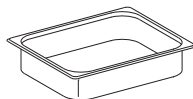

Solid cooking pan
12 3/4" x 10 1/2" x 2 1/2" (WxDxH)
325 x 265 x 65 mm (WxDxH)

Optional accessories

DGGL 4

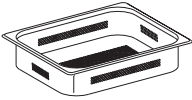

Perforated cooking pan
12 3/4" x 10 1/2" x 2 1/2" (WxDxH)
325 x 265 x 65 mm (WxDxH)

DGGL 5

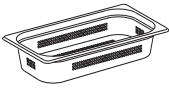

Perforated cooking pan
12 3/4" x 7" x 2 1/2" (WxDxH)
325 x 175 x 65 mm (WxDxH)

DGGL 6

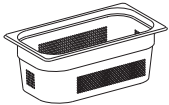

Perforated cooking pan
12 3/4" x 7" x 4" (WxDxH)
325 x 175 x 100 mm (WxDxH)

DGG 7

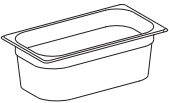

Solid cooking pan
12 3/4" x 7" x 4" (WxDxH)
325 x 175 x 100 mm (WxDxH)

DGGL 8

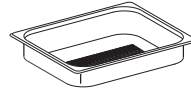

Perforated cooking pan
12 3/4" x 10 1/2" x 1 1/2" (WxDxH)
325 x 265 x 40 mm (WxDxH)

DGGL 12



Perforated cooking pan
17 11/16" x 15 3/8" x 1 9/16" (WxDxH)
450 x 390 x 40 mm (WxDxH)

DGGL 20

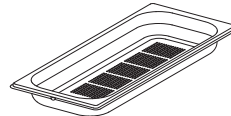

Perforated cooking pan
17 11/16" x 7 1/2" x 1 9/16" (WxDxH)
450 x 190 x 40 mm (WxDxH)

DGG 20

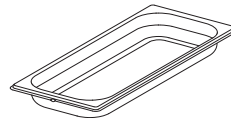

Solid cooking pan
17 11/16" x 7 1/2" x 1 9/16" (WxDxH)
450 x 190 x 40 mm (WxDxH)

Optional accessories

Lid for cooking pans

DGD 1/3



Lid for 12 3/4" x 7" (325 x 175 mm)
cooking pans

DGD 1/2

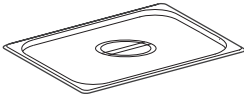

Lid for 12 3/4" x 10 1/2" (325 x 265 mm)
cooking pans

Cleaning and care products

DGCLean (8 oz. / 250 ml)



Special cleaning agent for removing stubborn soiling from the oven interior, particularly after roasting.

Descaling tablets (Qty 6)



For descaling the appliance

Additional accessories

Universal tray

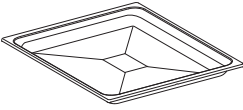

Universal tray for baking, roasting and broiling

Wire oven rack



1 wire oven rack for baking, roasting and broiling

Roast probe

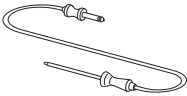

For precise temperature controlled cooking The roast probe monitors the internal temperature of the meat (core temperature).

FlexiClip telescopic runners

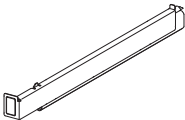

The FlexiClip telescopic runners can be clipped into any of the shelves and pulled out of the oven to their fullest extent.

Rack for cooking pans

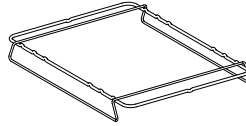

For holding 12 13/16" (325 mm) wide containers. Slides into the side runners in the appliance.

Round baking form

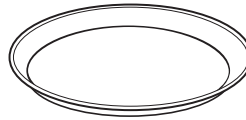

Suitable for cooking pizzas, flat cakes made with yeast or whisked mixtures, sweet and savoury tarts, baked desserts, and can also be used for deep frozen cakes and pizzas.

Not suitable for use with programs using steam

Optional accessories

Gourmet casserole dish

Die-cast aluminum casserole dish with non-stick surface. Slides into the side runners in the oven. Also suitable for use on an extended zone of an electric ceramic hob and in all Miele ovens.

Not suitable for use on gas or induction cooktops.

HUB 5000-XL

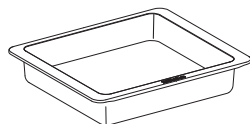

Maximum capacity approx. 16 lbs (8 kg)
Depth 13 3/4" (35 cm)

This oven dish will not fit in the oven with the lid on.

Lid for gourmet casserole dish

Suitable for HUB 5000-M

HBD 60-35

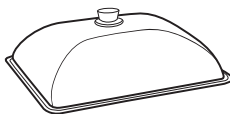

Suitable for HUB 5000-XL

Miele@home

The Miele@home System can only be fitted by an authorized Miele service technician. Please contact Miele for details of this system. It is not available in all countries.

IMPORTANT SAFETY INSTRUCTIONS - INSTALLATION

 Incorrect installation can result in personal injury and damage to property.

▶ Before connecting the appliance to the mains supply, ensure that the connection data on the data plate (voltage and frequency) match the mains electricity supply.

This data must correspond in order to avoid the risk of damage to the appliance. Consult a qualified electrician if in any doubt.

▶ Do not use an extension cord to connect this appliance to electricity. Extension cords do not guarantee the required safety of the appliance.

▶ The electrical outlet should be easily accessible after the appliance has been installed.

▶ The appliance must be positioned so that you can see the contents of a cooking pan placed on the top level. Otherwise you may risk scalding or burning yourself with hot water and food when taking containers out of the oven.

▶ Be certain your appliance is properly installed and grounded by a qualified technician. To guarantee the electrical safety of this appliance, continuity must exist between the appliance and an effective grounding system. It is imperative that this basic safety requirement be met. If there is any doubt, have the electrical system of the house checked by a qualified electrician.

All dimensions in this instruction booklet are given in mm and inches.

Detailed dimensions of oven front

PureLine front

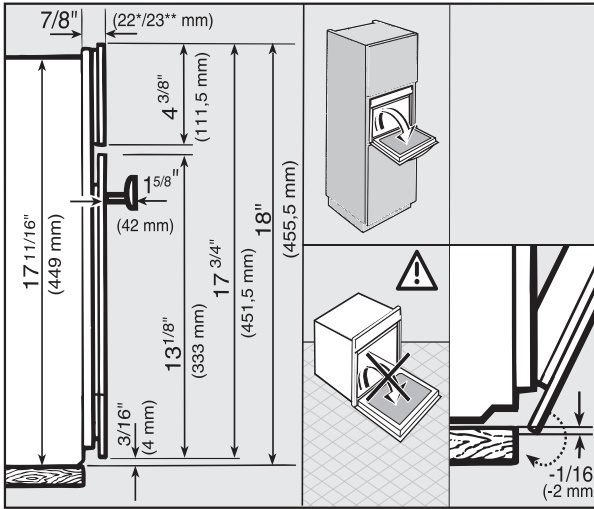

ContourLine front

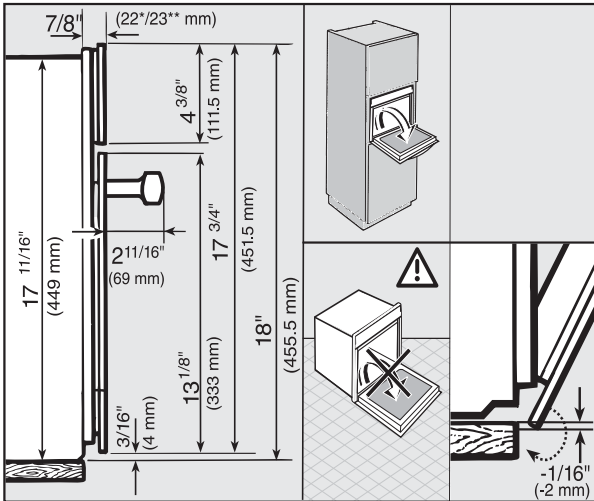

* Glass front / ** Metal front

Detailed dimensions of oven front

Control panel swivel range

The area in front of the control panel must not be blocked by anything (such as a door handle) that would hinder it from opening and closing.

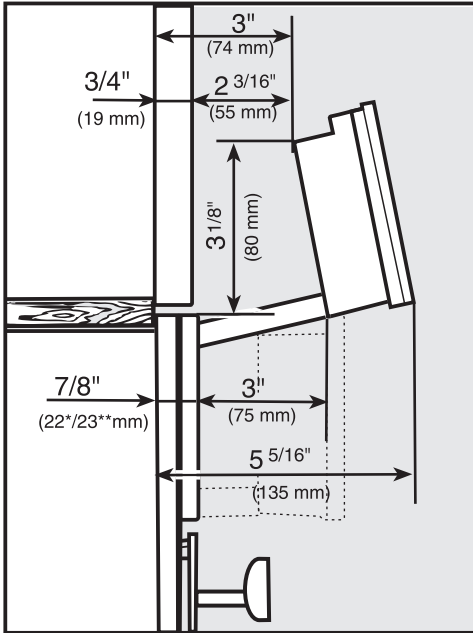

* Glass front / ** Metal front

Installation dimensions

Installation into a tall cabinet

The housing unit must not have a back panel installed behind the building-in niche.

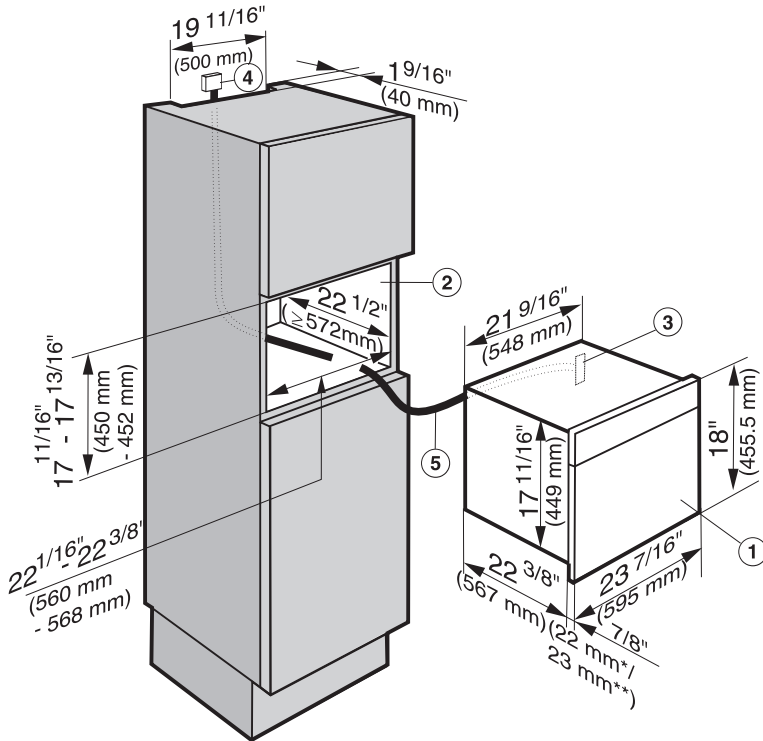

- ① Steam oven
- ② Niche
- ③ Pass-through for the power cord
- ④ Recommended position for electrical connection
- ⑤ Power cord

* Glass front / ** Metal front

Ventilation cut-outs

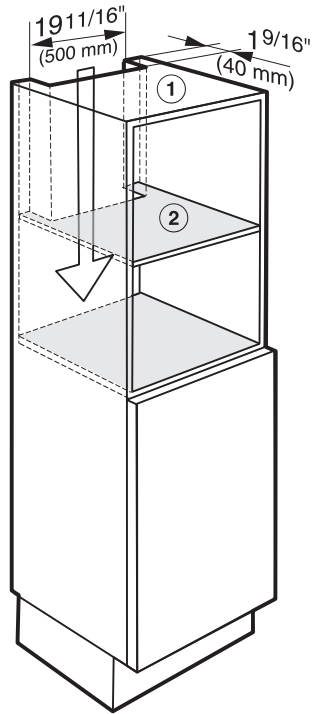

- ① Cut-out in the top of the unit
- ② Cut-out in the center shelf above the building-in niche

Installation dimensions

Undercounter installation

The housing unit must not have a back panel installed behind the building-in niche.

When building the appliance into a base unit underneath a cooktop, please also observe the installation instructions for the cooker and its respective installation depth (see the installation instructions for the cooktop).

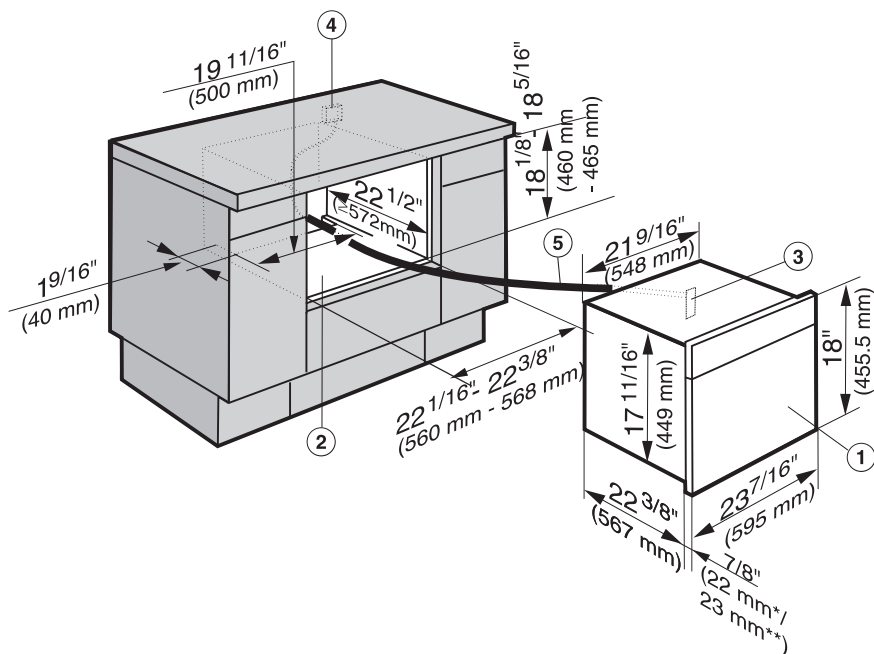

- ① Steam oven
- ② Niche
- ③ Pass-through for the power cord
- ④ Recommended position for electrical connection
- ⑤ Power cord

* Glass front / ** Metal front

Ventilation cut-outs

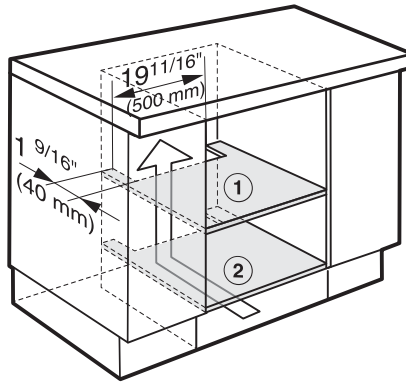

- ① Cut-out in the center shelf under the building-in niche
- ② Cut-out in cabinet base

Installation dimensions

Installation in combination with an oven

The housing unit must not have a back panel installed behind the building-in niche.

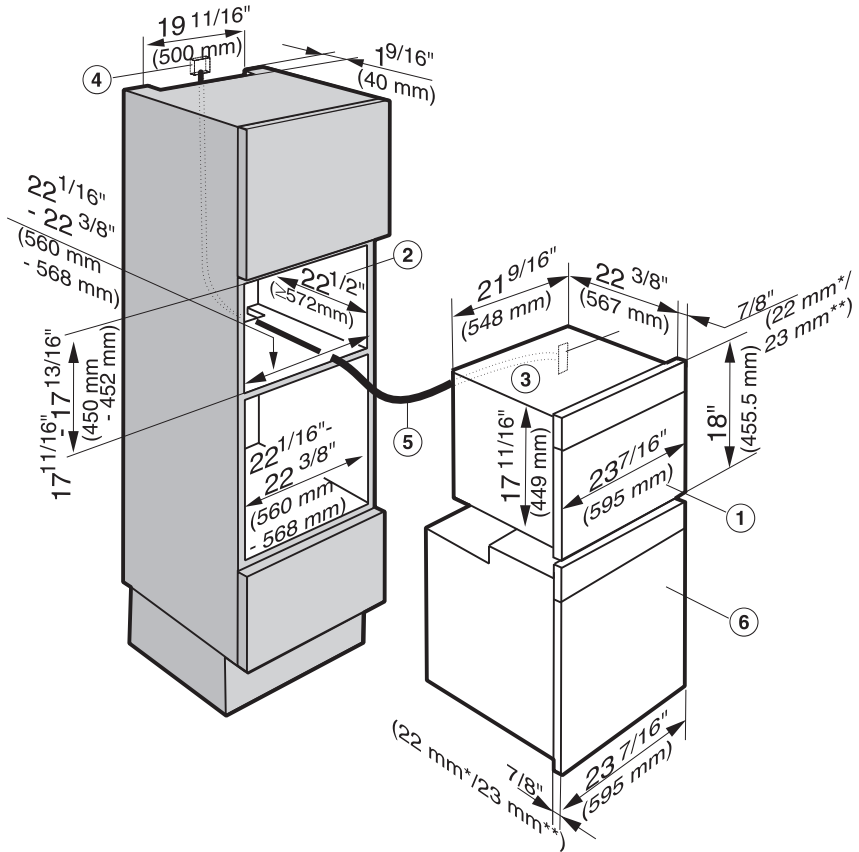

- ① Steam oven
- ② Niche
- ③ Pass-through for the power cord
- ④ Recommended position for electrical connection
- ⑤ Power cord
- ⑥ Oven

* Glass front / ** Metal front

Ventilation cut-outs

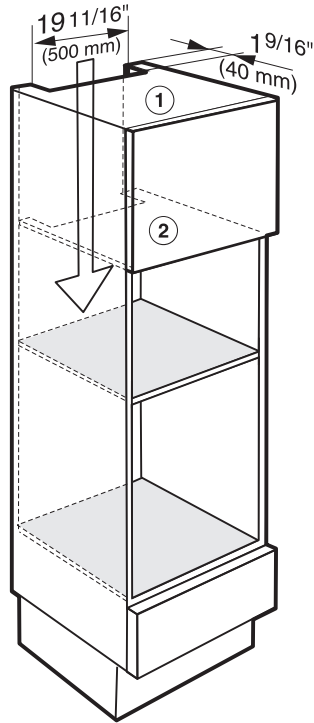

- ① Cut-out in the top of the unit
- ② Cut-out in the center shelf above the appliance building-in niche

For the oven ventilation cut-out, please see the information in the oven installation instructions.

Installation

Installing the steam oven

A fault can occur if the appliance is not correctly aligned.

For correct functioning of the steam generator, please make sure that the appliance is horizontally level. The maximum deviation should not exceed 2°.

- Push the appliance into position in the niche and align it. Make sure that the power cord and water intake and drain hoses do not get pinched or damaged when doing so.

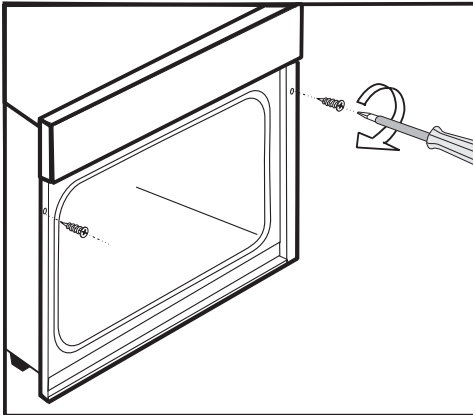

- Secure the appliance left and right using the screws supplied 1/8" x 1" (3.5 mm x 25 mm) to the sides of the unit, as illustrated.
- Connect the appliance to the electrical supply.
- Check the appliance for correct function in accordance with the Operating Instructions.

ATTENTION:

Before installation or servicing, disconnect the power supply by either removing the fuse, manually "tripping" the circuit breaker or unplugging the appliance. Pull the plug not the cord.

Installation work and repairs should only be performed by a qualified technician in accordance with all applicable codes and standards. Repairs and service by unqualified persons could be dangerous and the manufacturer will not be held responsible. Installation, repair, and maintenance work should only be performed by a Miele-authorized service technician. Work by unqualified persons can cause considerable danger to users. Miele cannot be held liable for any damage arising as a result of such work.

Before connecting the appliance to the power supply, make sure that the voltage and frequency listed on the rating label correspond with the household electrical supply. This data must correspond to prevent appliance damage. Consult an electrician if in doubt.

For safety reasons, the steam oven may only be used when it has been fully installed.

Installer:

- Please leave these instructions with the customer.

Connection

- Ensure that the connection data on the data plate (voltage, frequency, and fuse rating) match those of your electrical supply.

Power Supply

This appliance is equipped with a 5 ft (1.5 m) long power cord with a NEMA 6-20P three-prong grounding plug ready for connection.

240 V / 20 A / 60 Hz

Make sure that the connecting socket is accessible after the installation of the steam oven.

Replacing the power cord

Danger of electrical shock!

The power cord must only be replaced by a suitably qualified and competent person in accordance with current local and national safety regulations in order to avoid a hazard.

If the power cord needs to be replaced, it must be replaced with a special connection cable, type H 05 VV-F (PVC insulated), available from Miele.

Caring for the environment

Disposal of the packing material

The cardboard box and packing materials protect the appliance during shipping. They have been designed to be biodegradable and recyclable.

Ensure that any plastic wrappings, bags, etc. are disposed of safely and kept out of the reach of children. Danger of suffocation!

Disposal of your old appliance

Old electrical and electronic appliances often still contain valuable materials. However, they also contain harmful substances that were essential for the proper functioning and safe use of the equipment. Handling these materials improperly or disposing of them in your household waste can be harmful to your health and the environment. Therefore, please do not dispose of your old appliance with regular household waste.

Old appliances may contain materials that can be recycled. Please contact your local recycling authority about the possibility of recycling these materials.

Please be sure that your old appliance does not pose a danger to children while being stored for disposal.

Technical service, data plate, warranty

After sales service

In the event of a fault which you cannot easily correct yourself, please contact:

- your Miele dealer, or
- the Miele Technical Service Department.

See back cover for contact details.

Please quote the model and serial number of your appliance when contacting Miele.

Data plate

Adhere the extra data plate supplied with the appliance here. Ensure that the model number is the same as the one on the back of these operating instructions.

Warranty

For further information, please refer to your warranty booklet.

MieleCare

This service is available in USA only.

MieleCare, our Extended Service Contract program, gives you the assurance of knowing that your appliance investment is covered by 5 years of worry free ownership.

MieleCare is the only Extended Service Contract in the industry that guarantees repairs by a Miele Authorized Service Provider using genuine Miele parts. Only genuine Miele parts installed by factory trained professionals can guarantee the safety, reliability, and longevity of your Miele appliance.

Please note that unless expressly approved in writing by Miele's Service department, Extended Service Contracts offered by other providers for Miele products will not be recognized by Miele. Our goal is to prevent unauthorized (and untrained) service personnel from working on your Miele products, possibly doing further damage to them, you and/or your home.

To learn more about **MieleCare** Extended Service Contracts, please contact your appliance dealer or visit us online at:

www.mieleusa.com

Please have the model and serial number of your appliance available before contacting Technical Service.

The Miele logo consists of the word "Miele" in a bold, white, sans-serif font, set against a solid black rectangular background.

U.S.A.

Miele, Inc.

National Headquarters

9 Independence Way
Princeton, NJ 08540
Phone: 800-843-7231
Fax: 609-419-4298
www.mieleusa.com

Technical Service & Support

Nationwide

Phone: 800-999-1360
Fax: 888-586-8056
TechnicalService@mieleusa.com

Germany

Manufacturer

Miele & Cie. KG
Carl-Miele-Straße 29
33332 Gütersloh

Canada

Importer
Miele Limited

Headquarters and Miele Centre

161 Four Valley Drive
Vaughan, ON L4K 4V8
www.miele.ca

Customer Care Centre

Phone: 800-565-6435
905-532-2272
customercare@miele.ca

DGC 6500 / DGC 6600



en-US, CA

M.-Nr. 10 013 170 / 04